

User Manual

EM3E Series

EtherCAT Stepper Drive



Revision 1.1

©2018 Leadshine Technology Co., Ltd.

Leadshine Technology Co., Ltd (Headquarters)

Address: Floor 11, Block A3, iPark
1001 Xueyuan Avenue
Shenzhen, Guangdong 518055
China

Tel: 86-400-885-5521

Fax: 86-755-2640-2718

Web: www.leadshine.com

Sales: sales@leadshine.com

Support: tech@leadshine.com

Leadshine America, Inc.

Address: 26050 Towne Centre Dr.
Foothill Ranch, CA 926
USA

Tel: 1-949-608-7270

Fax: 1-949-608-7298

Web: www.leadshineusa.com

Sales: sales@leadshineusa.com

Support: support@leadshineusa.com



EtherCAT®
Conformance tested

EM3E Passed the ETC Laboratory Conformance Tested

EtherCAT® is a registered trademark and patented technology, licensed by Beckhoff Automation GmbH, Germany.

- ◆ **Thank you for purchasing Leadshine EM3E Series Products**
- ◆ **Please read this manual carefully before operating**
- ◆ **Please keep this manual appropriately.**

Record of Revisions:

Reversion	Data	Description of Release	Signed
V1.00	2017/11/02	Initial Release	Max
V1.10	2019/02/26	Add brake output, motor cable error,etc	Max

Preface

Thank you for choosing EM3E EtherCAT stepper drive system of Leadshine Technology Co., Ltd. This manual gives required knowledge & precautions for using EM3E Series Stepper Drives.

About EtherCAT:

EtherCAT (Ethernet for Control Automation Technology) is open network communication using real-time Ethernet between masters and slaves developed by Beckhoff Automation GmbH, Germany.

ETG (EtherCAT Technology Group) has control over it.

The Manual of EM3E Series Include:

- <EM3E Series EtherCAT Stepper Drive User Manual>

The user manual is about hardware, function description, parameter configuration, etc.

Please make sure to read carefully and refer to this specification after understanding the contents fully.

Please Pay Attention to The Following Reminders:

- Only technical personnel are allowed to install debug or maintain the product.
- To ensure correct wiring before power-on test. Make sure wiring is correct before power-on test.
- Incorrect voltage or power polar connection can cause damage to drive or other accidents.
- Contents of this manual are subject to change without prior notice for functional improvement, change of specifications or use's better understandings.
- Leadshine will not undertake any responsibility in case of user's unauthorized product reconstruction; product warranty will also be invalid.

Contents Table

1 Introduction.....	8
1.1 Product Introduction.....	8
1.2 EtherCAT Compare with Step/Direction.....	8
1.2.1 Stronger anti-disturbance ability.....	8
1.2.2 Enhanced performance.....	8
1.2.3 Simple wiring and long communication distance.....	8
1.2.4 Lower cost.....	8
1.3 Check of Product.....	9
1.3.1 Arrival inspection.....	9
1.3.2 Nameplate information.....	10
1.3.3 Part number.....	10
1.3.4 Accessories Information.....	10
1.3.5 Parts description.....	11
2 Installation.....	12
2.1 Storage and Installation Conditions.....	12
2.1.1 Storage condition.....	12
2.1.2 Operating ambience conditions.....	12
2.2 Mechanical Specification.....	12
2.3 Installation Direction and Space.....	12
3 Production Specifications.....	14
3.1 Electrical and Operating Specifications.....	14
3.2 Wiring Instructions.....	15
3.2.1 Power Supply Cable&Motor Cable.....	15
3.2.2 I/O Signal Cable.....	15
3.2.3 EtherCAT Communication Cable.....	15
3.3 Interface Specifications.....	16
3.3.1 Connectors Definition.....	16
3.3.2 Input Power Connector.....	16
3.3.3 Motor Connector.....	16
3.3.4 I/O Signals Connector.....	16
3.3.5 EtherCAT Communication Connector.....	17
3.3.6 EtherCAT ID (Site Alias) Setting.....	17
3.4 I/O Interface and Corresponding Parameters Setting.....	18
3.4.1 Digital Input.....	18

3.4.2 Digital Output.....	20
4 EtherCAT Technology.....	23
4.1 EtherCAT Technology Principles.....	23
4.2 EtherCAT Data Frame Structure.....	23
4.3 Synchronous Mode.....	24
4.3.1 Free running mode.....	24
4.3.2 Distributed clock synchronization mode.....	24
4.4 EtherCAT state machine.....	25
4.5 COE.....	26
4.5.1 COE VS CANopen DS301.....	26
4.5.2 EM3E network structure.....	26
4.5.3 Object dictionary.....	27
4.5.4 Service data object (SDO).....	28
4.5.5 Process data object (PDO).....	32
4.5.6 SDO VS PDO.....	37
4.5.7 Quick event.....	37
4.6 Slave station alias settings and network status display.....	38
4.6.1 Specification of network status display.....	38
4.7 Parameters saving.....	39
4.8 Restore factory parameters.....	39
5 EM3E CiA 402 Control Introduction.....	40
5.1 EM3E Stepper System Control Motion Steps.....	40
5.2 402 State Control and Transition.....	41
5.2.1 State Transition Diagram.....	41
5.2.2 CIA DSP402 control word.....	43
5.2.3 CIA DSP402status word.....	44
5.3 Control Modes Setting.....	46
5.3.1 Supported operation modes object (6502h).....	46
5.3.2 Operation Mode Object (6060h) and Operation Mode Display Object (6061h).....	46
5.3.3 Notes.....	46
5.4 Common Functions in different operation modes.....	46
5.4.1 Digital Input / Output.....	46
5.4.2 Rotation Direction Setting.....	49
5.4.3 Stop Mode Setting.....	50
5.4.4 Limit Switch.....	50
5.5 Operation Modes.....	50

5.5.1 Position Mode—PP Mode.....	50
5.5.2 Position Mode—CSP Mode.....	53
5.5.3 Position Mode—HM Mode.....	55
5.5.4 Velocity Mode—PV Mode.....	57
5.6 Touch Probe Function Instructions.....	58
5.6.1 Trigger Signal Setting.....	58
5.6.2 Related Object.....	59
5.6.3 I1 or I2 Pin Function Setting.....	60
5.6.4 The Object of Touch Probe Function Control.....	60
5.6.5 The Object of Touch Probe State.....	61
5.6.6 Latch Data Registers.....	61
5.6.7 Latch Counter Registers.....	62
5.6.8 Touch probe Action Switches On.....	62
5.6.9 Time Mode of Touch Probe.....	62
5.6.10 Other status indication of touch probe.....	63
6 Drive Operating Instructions.....	64
6.1 Function Operating.....	64
6.1.1 Save parameters.....	64
6.1.2 Factory reset.....	64
6.2 Before Using.....	64
6.3 Field Bus Product Network.....	64
6.3.1 Operation Mode.....	65
6.3.2 The Necessary Configuration.....	65
7 Alarm and Processing.....	66
7.1 Error Codes.....	66
7.1.1 EM3E Series Drives Errors.....	66
7.1.2 EtherCAT Communication Errors.....	67
8. Warranty.....	69
Appendix A. Object Dictionary.....	70
Appendix B. Homing Methods.....	76
Appendix C. Leadshine EM3E Compatible Power Supplies.....	83

1 Introduction

1.1 Product Introduction

The newly released EM3E series drives support CANopen over EtherCAT (CoE) control and CiA 402 operating modes including Profile Position (PP), Profile Velocity (PV), Homing (HM) and Cyclic Synchronous Position (CSP). The products can be matched with most EtherCAT controller/PLC of many brands such as Leadshine, Beckhoff, Omron, etc. The EM3E series has excellent performance including enhanced reliability, super-low stepper noise, anti-resonance and low-speed ripple smoothing and remains 60% less cost than EtherCAT servo products at least.

1.2 Features

- Low noise and vibration, smooth motion
- CANopen over EtherCAT (CoE) with full support of CiA402,100Mbps full-duplex.
- Support operation modes: Profile Position, Profile Velocity, Cyclic Synchronous Position, Homing
- 5 digital inputs, 2 optically isolated digital outputs include alarm and brake for EM3E-522/556/870
7 digital inputs, 6 optically isolated digital outputs and brake output for EM3E-A882
- 20-50VDC supply voltage for EM3E-522 and EM3E-556, max 5.6A output current
20-80VDC supply voltage for EM3E-870, max 7.0A output current
20-80VAC or 30-100VDC supply voltage for EM3E-A882, max 8.2A output current
- Protections for over voltage, over current, motor cable error, etc.

1.3 EtherCAT Compare with Step/Direction

1.3.1 Stronger anti-disturbance ability

Traditional step/direction transmission cables have lower reliability for the reason of EMC interference, whereas EtherCAT communication with shielded cables have stronger anti-interference ability, and inbuilt error detection. Limit and handling mechanisms can also bring more reliable transmission and longer communication distance.

1.3.2 Enhanced performance

EtherCAT is the fastest industrial Ethernet technology by and large, and it also synchronizes with nanosecond accuracy. This is a huge benefit for all applications in which target system is controlled or measured via the bus system.

1.3.3 Simple wiring and long communication distance

In step/direction control mode, the controller/PLC needs to connect with each drive to send control signals, which may lead to intensive signal cables and wiring complexity if many drives are required. While in EtherCAT applications, the controller/PLC just needs to connect with one of the drives and then line topology with others. Additionally, the EtherCAT communication allows longer distance up to 100 meters maximum.

1.3.4 Lower cost

EtherCAT delivery has the features of industrial Ethernet at a price similar or even below that of traditional control mode. The only hardware required by the master device is an Ethernet port, instead of some expensive interface cards or co-processors. Since EtherCAT doesn't require high-speed pulse modules or other active infrastructure components, the costs for these components and their installation, configuration, and maintenance are also eliminated.

Their connection typologies are as below:

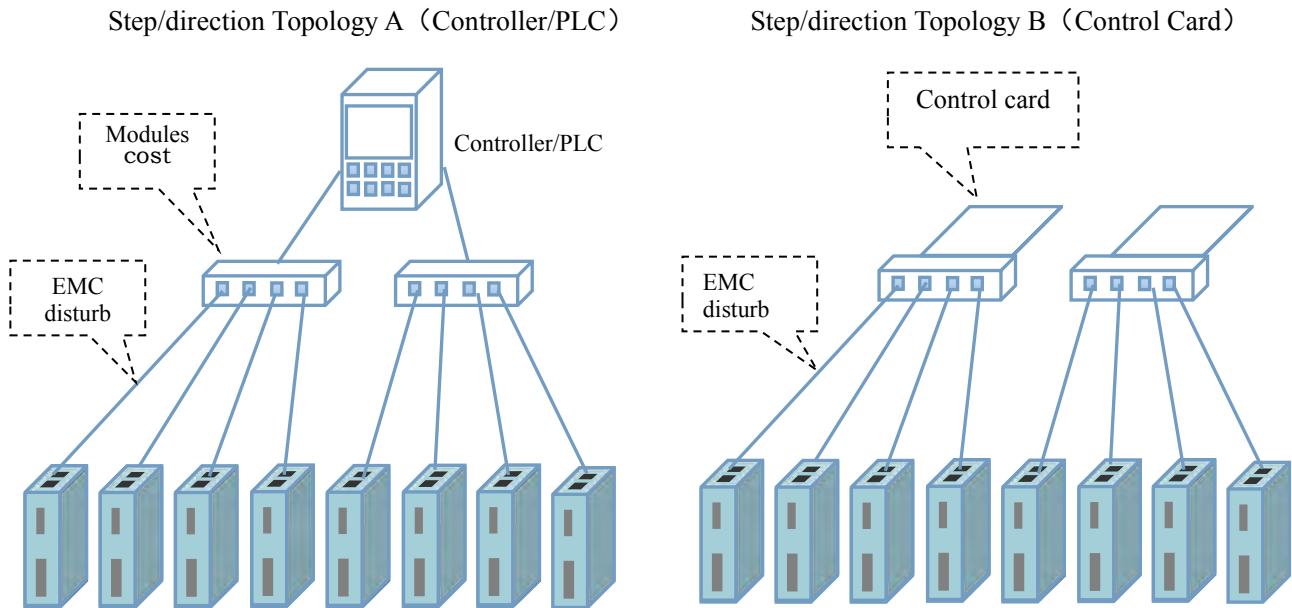

Figure 1.1: Step/direction Topology

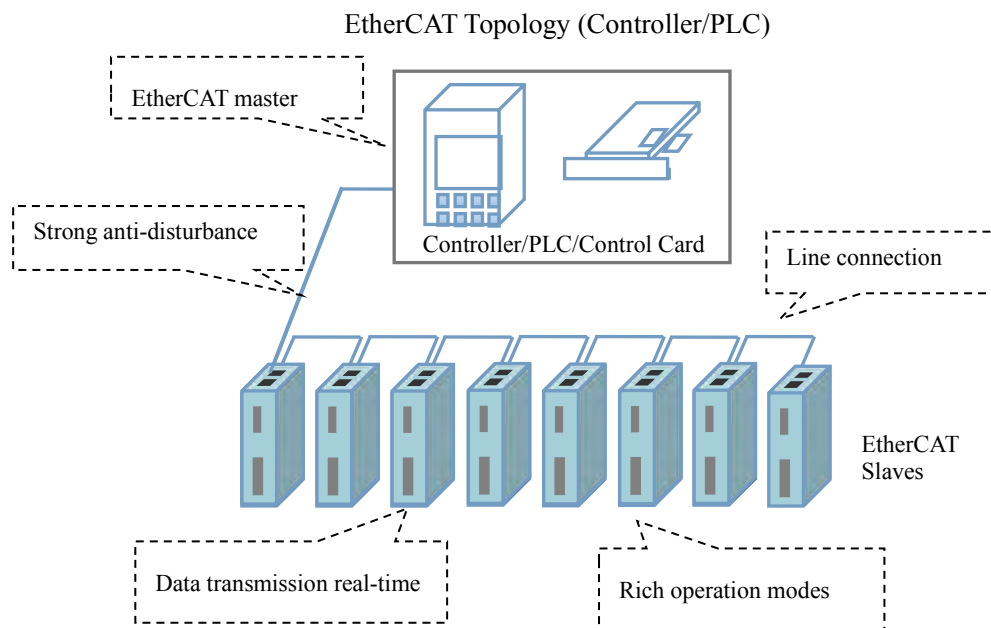

Figure 1.2: EtherCAT Topology

1.3 Check of Product

1.3.1 Arrival inspection

- Check whether the surface of the product is damaged or not during transportation.
- Check the nameplate models of the drive and motor.
- Check if it is fully equipped with accessories. Accessories include a page of paper of brief description, power supply and motor output connector, control I/O signal connector.

CAUTION

- Neither the damaged nor missing accessories of stepper system is allowed to install.
- Contact Leadshine or local distributor if any failure was found.

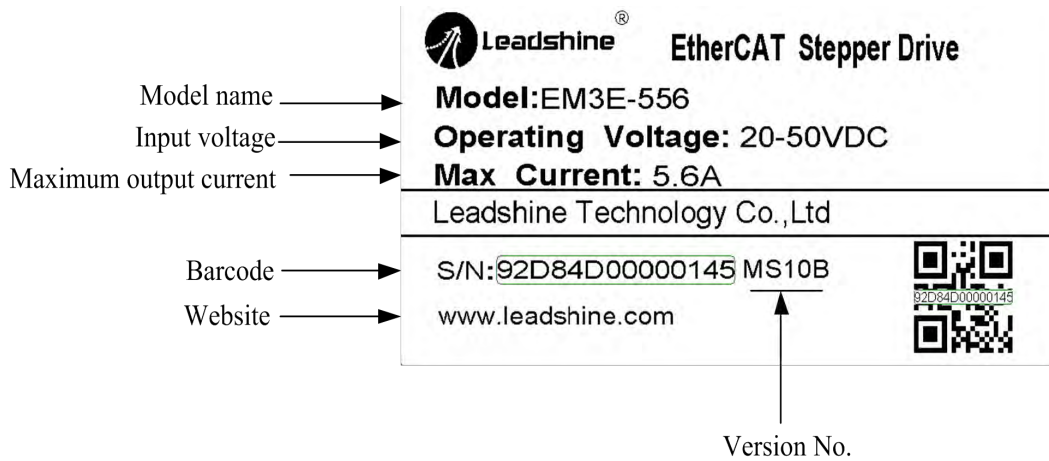
1.3.2 Nameplate information

Model name → **Model: EM3E-556**

Input voltage → **Operating Voltage: 20-50VDC**

Maximum output current → **Max Current: 5.6A**

Barcode → S/N: 92D84D00000145 MS10B

Website → www.leadshine.com



Version No. → MS10B



1.3.3 Part number

EM3E - 5 56 - □
1
2
3
4
5

- 1 Series Name
EM3: 3rd generation digital stepper drives
- 2 Communication Mode
E: EtherCAT
- 3 Maximum Operating Voltage
5: 50VDC
- 4 Maximum Output Current
56: 5.6A
- 5 Customized Code
Blank: standard

1.3.4 Accessories Information

Name	Number	Picture	Description	Need to cost extra
Power supply terminal	1		Power supply cable with 1.5m length	No
Motor terminal	1		Motor cable with 1.5m length	No

I/O signal terminal	1		10-pin terminal for EM3E-522/556/870	No
	1		22-pin terminal for EM3E-A882	No
Communication cable	1		Optional length: 0.1m, 0.2m, 0.3m, 0.4m, 1m, 1.5m, 2m, 3m, 5m, 7m, 10m, 15m, 20m	Yes

1.3.5 Parts description

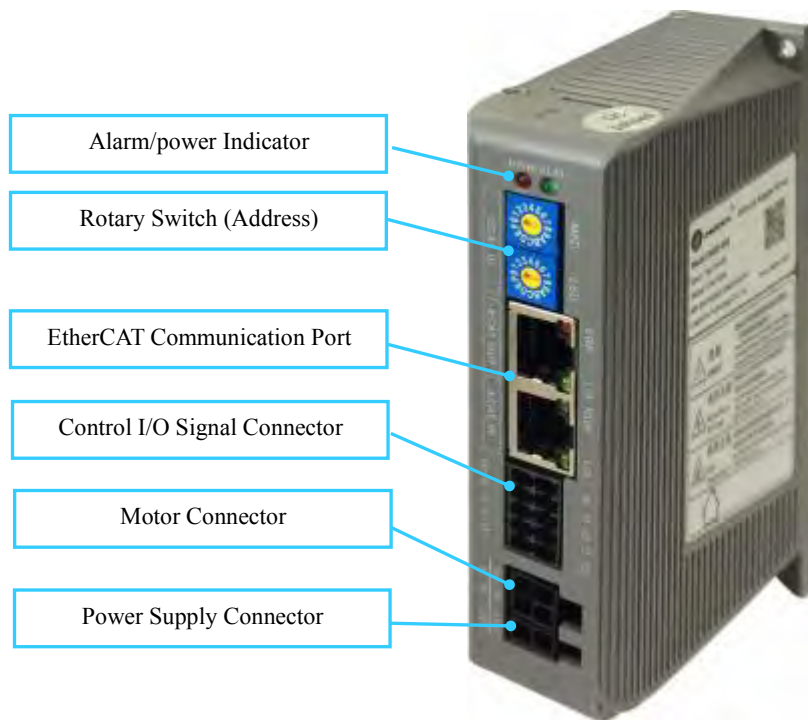

2 Installation

2.1 Storage and Installation Conditions

2.1.1 Storage condition

- Correctly packaged and store in a clean and dry environment where direct sunlight is avoided.
- Store within an ambient temperature range from -20°C to $+65^{\circ}\text{C}$.
- Store within a relative humidity ranging from 40% to 90% and non-condensed.
- Avoid any type of exposure to corrosive gases.

2.1.2 Operating ambience conditions

- Temperature ranging from 0°C to 50°C . The ambient temperature of drive for long-term reliability should be under 40°C . Please install the drive in a well-ventilated area.
- Operation within a relative humidity ranging from 40% to 90% and non-condensed.
- Vibration lower than 0.15mm at a frequency of 10Hz-55Hz.

	<p>CAUTION</p> <ul style="list-style-type: none"> • DO NOT mount the drive or motor in a location subjected to corrosive or flammable gases, and combustibles. • Please mount the drive and motor in an indoor electric control cabinet without liquid where direct sunlight is avoided. • DO NOT mount the drive and motor in a location subjected to airborne dust. • Please ensure grounding wires are securely connected
--	---

2.2 Mechanical Specification

Unit: mm, 1inch=25.4mm

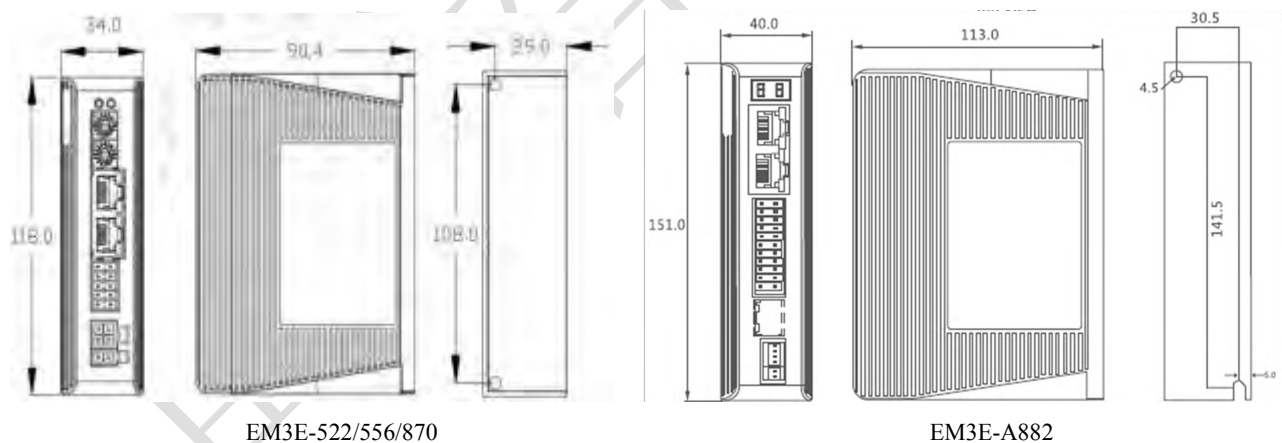

Figure 2.1 EM3E series mechanical drawing

2.3 Installation Direction and Space

- The mounting of drive, wiring and motor should be under the regulations of EN 61800-5-1.
- Incorrect installation may result in a drive malfunction or premature failure of the drive and/or motor. Please follow the guidelines in this manual when installing.
- The drive should be mounted perpendicular to the wall or in the control panel.
- In order to ensure the drive is well ventilated, ensure that the all ventilation holes are not obstructed and sufficient free space is given to the drive, and a cooling fan is mounted in the control panel.
- Please ensure grounding wires are securely connected.

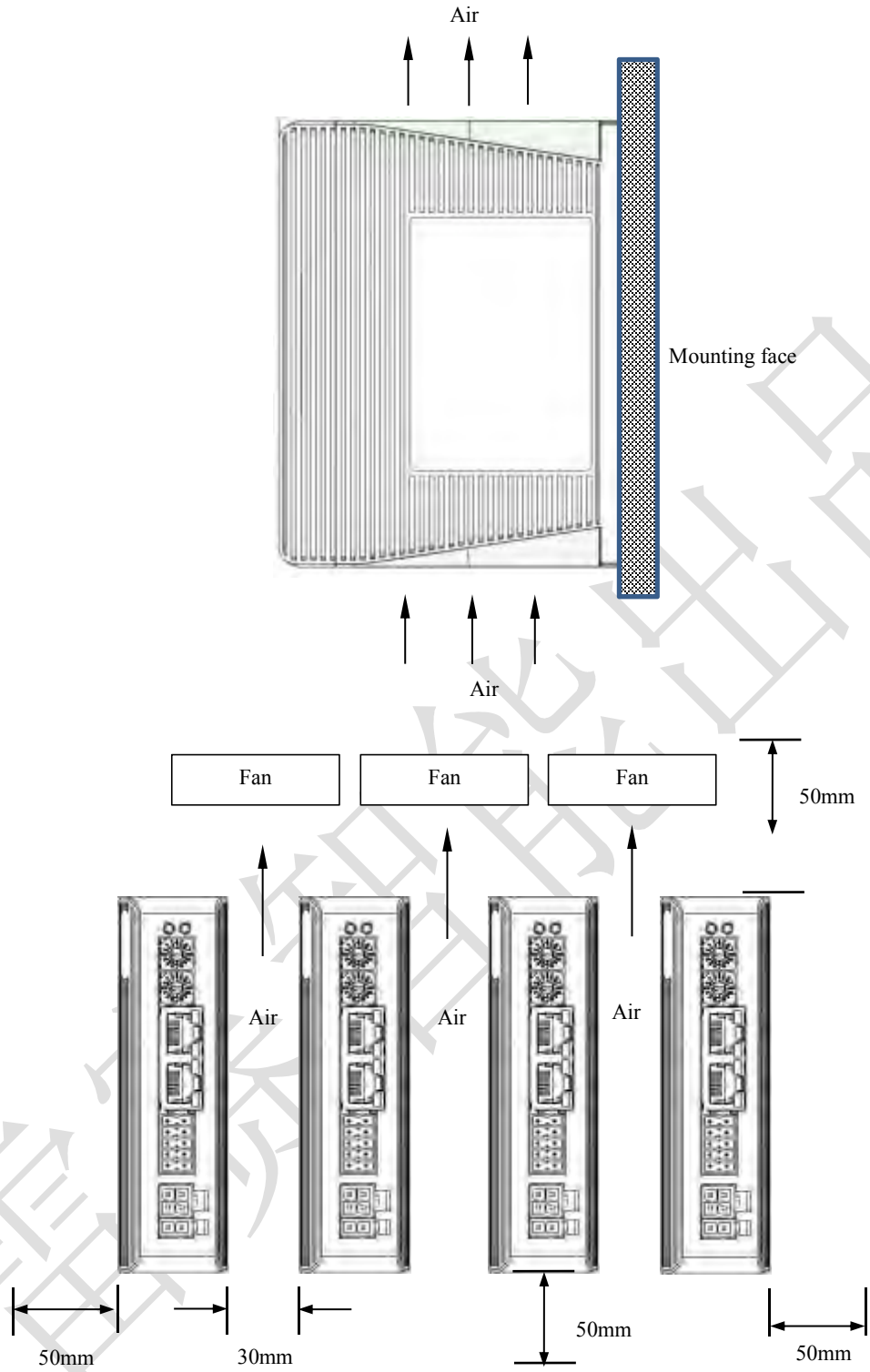

Figure 2.2 EM3E series installation drawing

3 Production Specifications

3.1 Electrical and Operating Specifications

Table 3.1: Electrical and Operating Specifications

Parameters	EM3E-522	EM3E-556	EM3E-870	EM3E-A882
Supply Voltage	20 - 50Vdc	20-50Vdc	20-80Vdc	20-80VAC or 30-100VDC
Output Current (Peak)	0.5-2.2A	1.0-5.6A	2.1- 7.0A	3.2- 8.2A
Size (H*W*L mm)	118*90.4*34			151*113*40
Weight (kg)	0.57			0.85
Matched Motor	NEMA 11,17	NEMA 17, 23	NEMA 23, 24	NEMA 34
Input Signals	Home Input, Positive Limit, Negative Limit, Touch Probe, quick stop, etc.			
Output Signals	Brake, Alarm, Master Station Control, etc.			
Protection Functions	Over Current, Over Voltage, Limit, Excess Velocity, motor cable error, etc.			
PC Software	None			
Communication Port	RJ45			
Operating Environment	Environment	Avoid dust, oil ,fog and corrosive gases		
	Operating Temperature	0-50°C(32 F – 122 F)		
	Storage Temperature	-20°C - 65°C(-4 F – 149 F)		
	Humidity	40-90%RH		
	Vibration	10-55Hz/0.15mm		
	Mount	Vertical or horizontal mounting		

3.2 Wiring Instructions

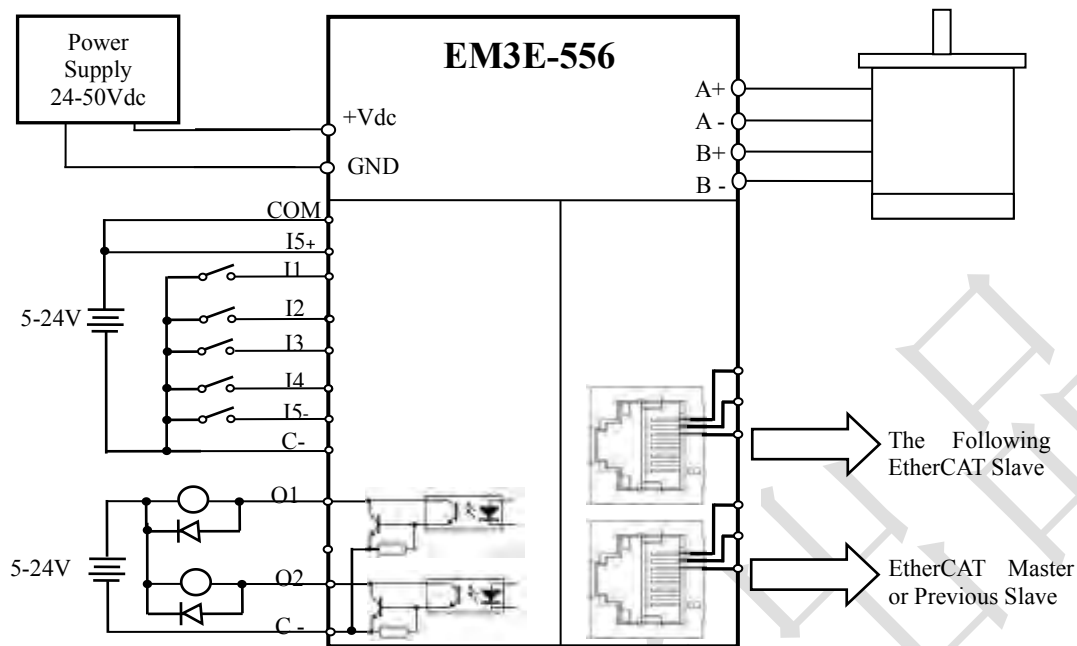

Figure 3.1 EM3E series wiring diagram

Note: There are two EtherCAT communication ports above, one of them is input port which connects with master station or previous slave, and the other is output port which connects with the following slave.

3.2.1 Power Supply Cable&Motor Cable

- Wire diameter: +VDC, GND, A+, A-, B+, B- terminal wire diameter $\geq 0.3\text{mm}^2$ (AWG15-22).
- A noise filter which can improve anti-interference performance is recommended to be connected between power supply and drive.

3.2.2 I/O Signal Cable

- Wire diameter: I1, I2, I3, I4, I5+, I5-, C+, C-, O1, O2 terminal wire diameter $\geq 0.12\text{mm}^2$ (AWG24-26)
- Recommend to adopt shielded twisted pair cable with a length of less than 3 meters (the shorter the better).
- Wiring: As far as possible away from the power line wiring, in order to prevent interference
- Please connect surge absorber to inductive device, such as anti-parallel diode for DC coil, parallel RC-snubbers circuit for AC coil.

3.2.3 EtherCAT Communication Cable

It is recommended to use standard Ethernet network cables that do not exceed 100 meters.

CAUTION



- DO NOT connect the polarity of power supply reversely.
- Cables must be fixed and far away from motor cover and drives heat sink.
- Be sure to turn off power and wait for at least 5 minutes when using EM3E-870, and then you can transport, wiring and inspect the drives and motors.

3.3 Interface Specifications

3.3.1 Connectors Definition

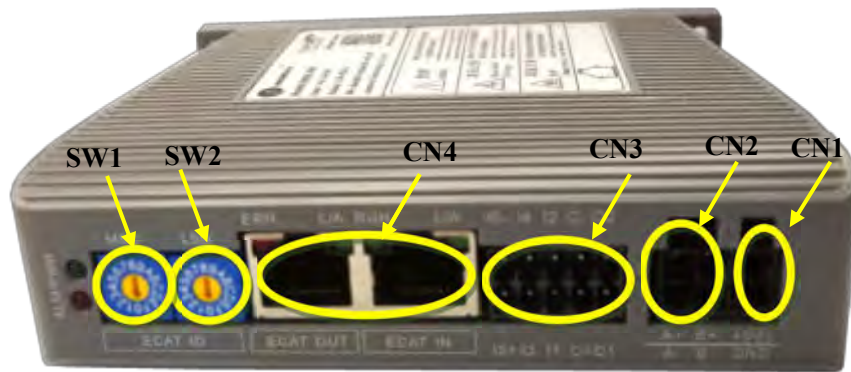



Figure 3.2 EM3E series connectors

Name	Description
CN1	Input power connector
CN2	Motor connector
CN3	I/O signals connector
CN4	EtherCAT communication connector
SW1	Setting communication high address
SW2	Setting communication low address

3.3.2 Input Power Connector

Name	Pic	PIN	Signal	Description
CN1		1	VDC	24V- 50V
		2	GND	GND

3.3.3 Motor Connector

Name	Pic	PIN	Signal	Description
CN2		1	A+	Motor phase A+
		2	B+	Motor phase B+
		3	A-	Motor phase A-
		4	B-	Motor phase B-

3.3.4 I/O Signals Connector

Name	Pic	PIN	Signal	I/O	Description
		1	O1	O	Digital OC output 1, single-end, Max. 24V/50mA, alarm output

CN3		2	O2	O	Digital OC output 2, open drain, Max. 24V/50mA, brake output.
		3	C+	I	Input common voltage 5- 24V, provided by controller/PLC
		4	C-	O	Output common ground
		5	I1	I	Digital input 1, single-end, high level 5-24V, probe 1 function
		6	I2	I	Digital input 2, single-end, high level 5-24V, homing function
		7	I3	I	Digital input 3, single-end, high level 5-24V, positive limit function
		8	I4	I	Digital input 4, single-end, high level 5-24V, negative limit function
		9	I5+	I	Digital input 5+, difference, high level 5-24V
		10	I5-	I	Digital input 5-, difference, high level 5-24V

Remark: (1) I/O interface and corresponding parameter setting refer to [section 3.4](#)

(2) The CN3 of EM3E-A882 is a terminal with 22pin.

3.3.5 EtherCAT Communication Connector

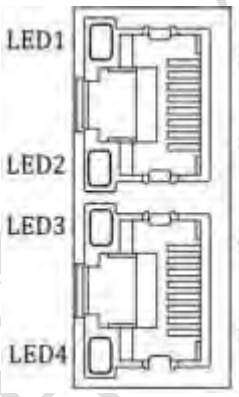
Name	Pic	PIN	Signal	Description
CN4		1, 9	E_TX+	EtherCAT TxD+
		2, 10	E_TX-	EtherCAT TxD-
		3, 11	E_RX+	EtherCAT RxD+
		4, 12	/	/
		5, 13	/	/
		6, 14	E_RX-	EtherCAT RxD-
		7, 15	/	/
		8, 16	/	/
		Cover	PE	Shield earthing
Note	(1) LED1 is Link/Activity IN indicator, green (2) LED3 is Link/Activity OUT indicator, green (3) LED2 is RUN indicator, green (4) LED4 is ERR indicator, red			

3.3.6 EtherCAT ID (Site Alias) Setting

The EtherCAT ID (Site Alias) of EM3E series can be set by the following 3 methods:

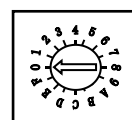

MSD (SW1)

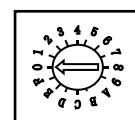

LSD (SW2)

Setting via rotary switch

When 2151h is set to value '0', user can set a value non-zero via the two rotary switches as the ID address of slave, the specific definition is as below:

The EtherCAT ID of drives comes from the constituent hexadecimal value by rotary switch 1 (SW1) and rotary switch 2 (SW2). For example, when the SW1 is set value 'A', and the SW2 is set value '8', the ID is 168 (decimal).

Setting via reading the SII site alias of ESC

The EtherCAT master can configure site alias to the EEPROM address 0004h of ESC, when object 2051h is set to 0, and the both two rotary switches are set to 0, the value at address 0004h is the site alias of the slave, activated after restarting the power supply.

Setting via the site alias of object dictionary

When the address 2151h is set to 0, the value of address 2150h is as the site alias, activated after restarting the power supply.

Note: The EtherCAT ID address is activated after restarting the power supply for above three methods.

3.4 I/O Interface and Corresponding Parameters Setting

3.4.1 Digital Input

Wiring

There are two types of input signals: single-ended and differential. the wirings are as below:

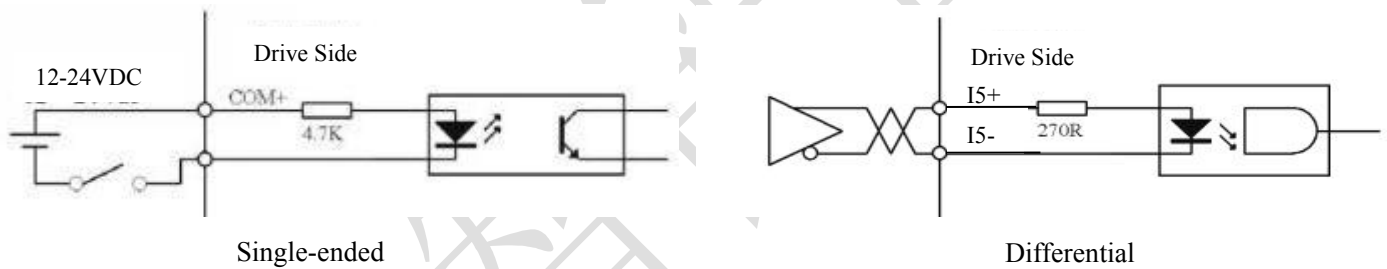

Figure 3.3 Input Interface Wiring

Note:

- (1) Controller/PLC/Control card should provide input DC power 12-24V (5-24VDC is allowed, but 12-24V is recommended), current $\geq 100\text{mA}$.
- (2) If the polarity of input DC power is reversed, the EtherCAT stepper drive won't work; you need to turn the wiring.

Mainly parameters related to digital input

Parameter Address	Name	Access	Default Value	Range	Description
Index + sub-index					
2152+01	Digital input function 1	R/W/S	32	0-32768	1: homing signal 2: positive limit 4: negative limit 8: emergency stop 16: user-defined 32: touch probe 1 64: touch probe 2

2152+02	Digital input 2 function	R/W/S	1	0-32768	1: homing signal 2: positive limit 4: negative limit 8: emergency stop 16: user-defined 32: touch probe1 64: touch probe2	
2152+03	Digital input 1 function	R/W/S	2	0-32768	1: homing signal 2: positive limit 4: negative limit 8: emergency stop 16: user-defined 32: touch probe1 64: touch probe2	
2152+04	Digital input 1 function	R/W/S	4	0-32768	1: homing signal 2: positive limit 4: negative limit 8: emergency stop 16: user-defined 32: touch probe1 64: touch probe2	
2152+05	Digital input 1 function	R/W/S	16	0-32768	1: homing signal 2: positive limit 4: negative limit 8: emergency stop 16: user-defined 32: touch probe1 64: touch probe2	
2153+01	Digital input 1 filter time	R/W/S	1000	50-60000	unit:us	Note: An overlong filter time may cause time delay of control command
2153+02	Digital input 2 filter time	R/W/S	1000	50-60000	unit:us	
2153+03	Digital input 3 filter time	R/W/S	1000	50-60000	unit:us	
2153+04	Digital input 4 filter time	R/W/S	1000	50-60000	unit:us	
2153+05	Digital input 5 filter time	R/W/S	1000	50-60000	unit:us	

2154	Digital input active level configuration	R/W/S	0	0-65535	0: active low level (default) 1: active high level (bit0 mapping input1, and so on)
------	--	-------	---	---------	---

Note: (1) I/O signal pin assignments refer to [section 3.3.4 connector –CN3](#).

Other parameters related to digital input

Reading digital input active level state

2155	Digital input state	RO	0	0-32768	0: active low level 1: active high level (bit0 mapping input1, and so on)
------	---------------------	----	---	---------	---

Reading digital input function state

60FD	Digital input function	RO	unsigned 32 bits	bit0: negative limit bit1: positive limit bit2: homing signal bit16: emergency stop bit26: Probe1 trigger complete instructions bit27: Probe2 trigger complete instructions bit17-bit21: mapping the input level of I1-I5 (when they are set to user-defined function) Note: Field bus version 202 or above are valid
------	------------------------	----	------------------	---

3.4.2 Digital Output

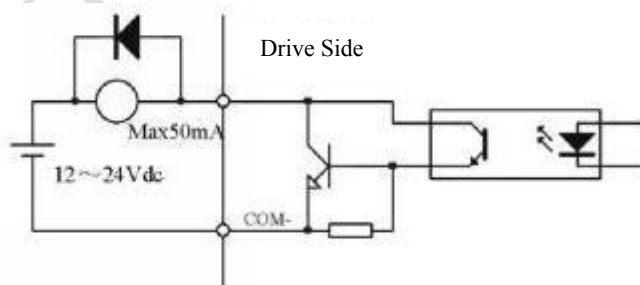

Figure 3.4 Output Interface Wiring

Note:

- (1) The power supply (12-24VDC) above is provided by user, and if the polarity of power supply is reversed, it will damage the drive.
- (2) Digital output is OC output, the provided power supply (12-24VDC) should be under this limit of 50mA/25V, otherwise it will cause damage to the drive.,
- (3) It must connect a freewheeling diode in parallel as above if the load is inductive such as relays, if the diode is reversed, it will damage the drive.

Digital output-related parameter list

Parameter Address	Number	Access	Default Value	Range	Description
Index + sub-index					
2005+01	Digital output 1 function	R/W/S	1	1-16	1: alarm output 4: in-position output 8: brake output 16: master station control
2005+02	Digital output 2 function	R/W/S	8	1-16	1: alarm output 4: in-position output 8: brake output 16: master station control
2008	Digital output level	R/W/S	0	0-3	0: positive logic 1: negative logic Bit 0 is mapping output1 Bit 1 is mapping output2

When the bit4 of object 2005h+01/02 is set to 1(the value of 2005h+01 or 2005h+02 is 16), the related parameter is set as below:

Parameter Address	Number	Access	Data Type	Description
Index + sub-index				
60FE+01	Output function available	R/W	unsigned 32 bits	When I/O output function set to master station control, master controller can use the combination of 60FE+01 and 60FE+02 to control I/O output: When bit16 of 60FE+01 and 60FE+02 are both '1', O1 have output When bit17 of 60FE+01 and 60FE+02 are both '1', O2 have output, and so on.....
60FE+02	Output function enable	R/W	unsigned 32 bits	

3.4.3 Brake Output

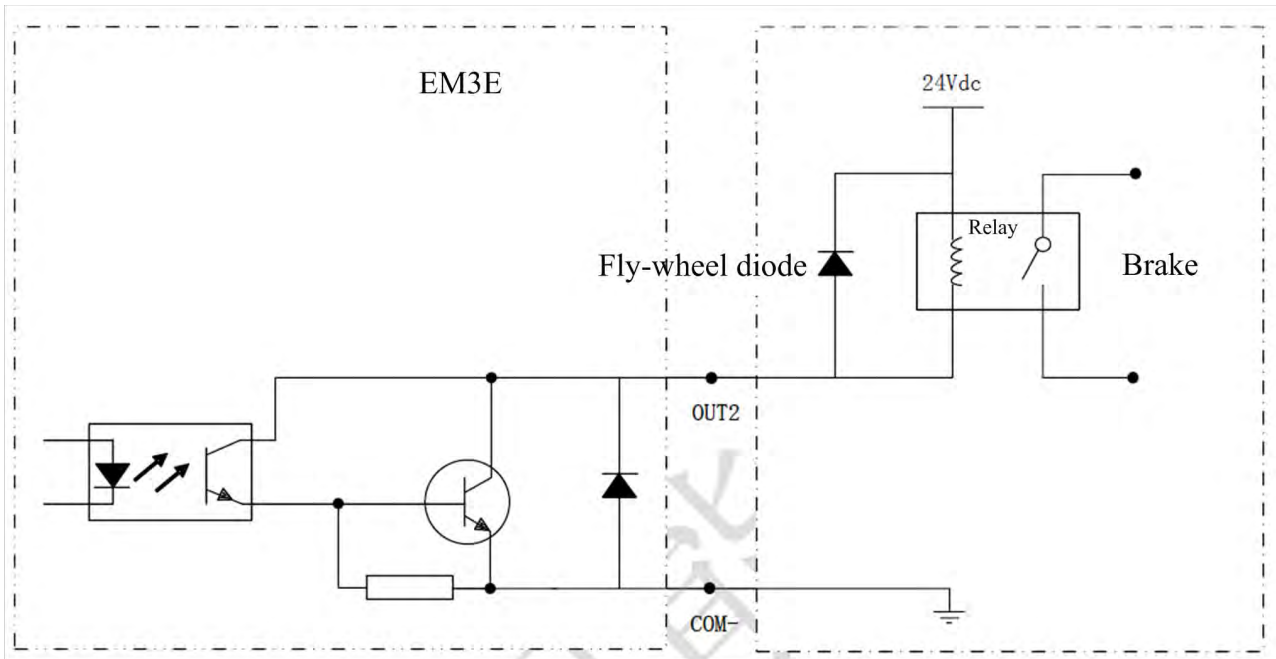

Figure 3.5 Brake Output Wiring

Note:

(1) An external relay and a fly-wheel diode must be connected, as shown in the figure above.

The version of EM3E series from V1.1A, the output 2 default function (2005 +02) is changed from in position to brake, and other related object dictionaries are as follows:

Parameter Address	Number	Access	Default Value	Range	Description
Index + sub-index					
4003	Time delay for loosening brake	R/W/S	50ms	0-3000	Time from the enable state to the release of the brake
4004	Time delay for locking brake	R/W/S	50ms	0-3000	Time from non-enabled status to shutdown PWM

4 EtherCAT Technology

4.1 EtherCAT Technology Principles

In the network composed by traditional Ethernet devices, each device can receive all the data packets in the network. The useful information of specified devices must be extracted one by one in the application layer, which could seriously affect the efficiency of the application layer.

EtherCAT technology has broken through the system limitations of traditional Ethernet solutions and the connection points no longer need to receive all data packets of network like other Ethernets. When the data frame passes through each device, the EtherCAT slave station reads the corresponding address data when the message passes through its node. Similarly, the input data can be inserted into the message when the message is passed. The slave station identifies the relevant commands and processes them when the frame is delivered (a few nanoseconds delay). This process is implemented by hardware in the slave controller; therefore it has nothing to do with the performance of the protocol stack processor. Since the rates of available data which arrive at many devices through Ethernet frames are increased by over 90% in both transmit and receive directions, full use of the 100BaseTX full duplex function enables the effective data rate of $> 100 \text{ M Bit/S}$ ($> 2 * 100 \text{ M Bit/S} * 90\%$) to be achieved.

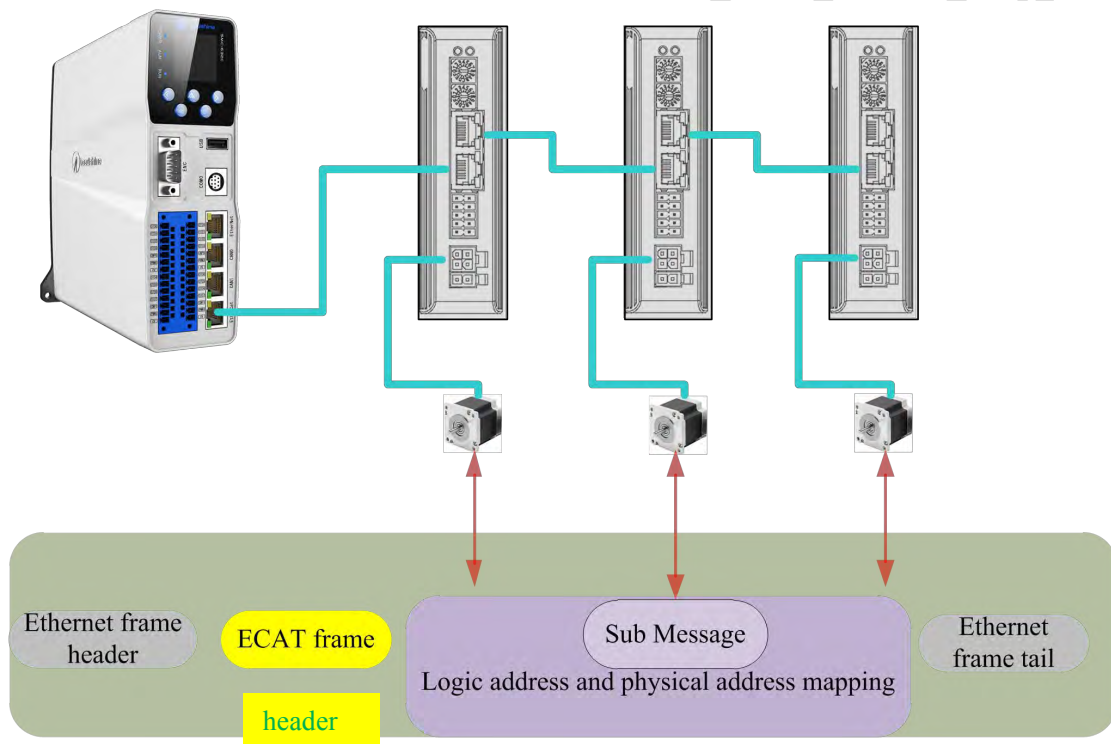
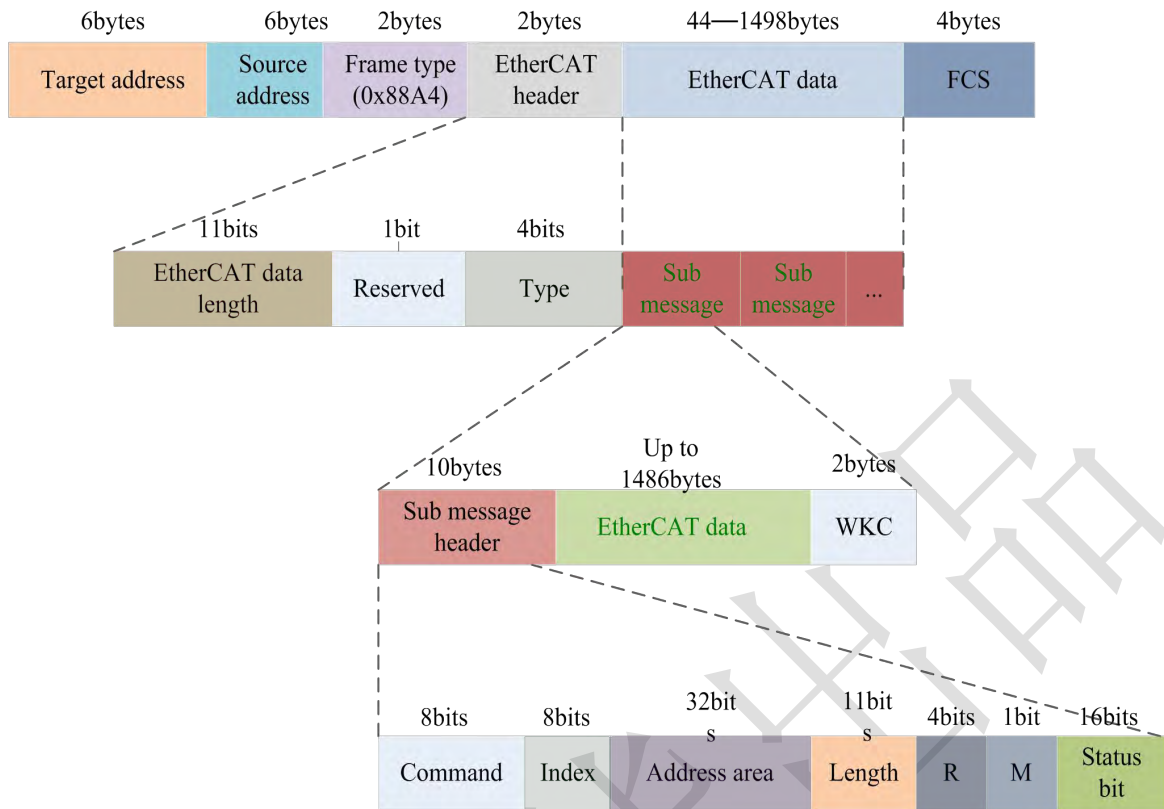

Figure 4.1: Digital packaging of process data

4.2 EtherCAT Data Frame Structure

EtherCAT uses Ethernet data frames for transmission; the frame type is fixed to 0x88A4. EtherCAT data frame contains two bytes of EtherCAT frame header and 44-1498 bytes of EtherCAT data. The EtherCAT data region consists of one or more EtherCAT sub messages, each of which corresponds to a storage area of the slave station. EtherCAT data frame structure is shown in figure 4.2. And the specific meaning of the data frame structure is shown in Table 2.1.

Figure 4.2 : EtherCAT data frame structure
Table 4.1: EtherCAT frame structural meaning

Frame structure	Meanings
Target address	Receiver MAC address
Source address	Sender MAC address
EtherCAT frame header: data length	EtherCAT the total length of all sub messages in the data region
EtherCAT frame header: type	1: communication with slave stations; other reserved
FCS	Frame check

4.3 Synchronous Mode

4.3.1 Free running mode

EM3E uses asynchronous mode to process data sent by the main station under free running mode, it applies only to asynchronous motion modes, such as origin mode, protocol positions mode, etc.

4.3.2 Distributed clock synchronization mode

EM3E uses the distributed clock synchronization mode shown in Fig. 4.3, which reads the process data immediately after the master station transmits the process data to the slave station, then wait for the sync signal to trigger the process data and act on the drive.

The process data must reach the EM3E drive ahead of the SYNC0 signal T1 time, and the drive has completed the analysis of the process data and the related control calculations before the SYNC0 event arrives, when the SYNC0 event is received, EM3E immediately implements the control action, and thus having a higher synchronization performance. It applies to the EM3E synchronous motion pattern.

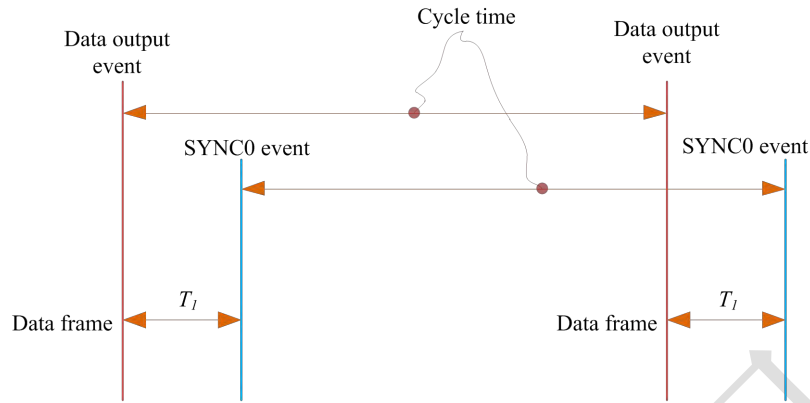
Figure 4.3: High performance synchronous mode

4.4 EtherCAT state machine

EtherCAT state machine, commonly known as "communication state machine", is mainly used for the management of communication between master and slave stations, and the communication function mainly contains mail and process data communication. The EtherCAT state transition relationship is shown in Figure 4.4.

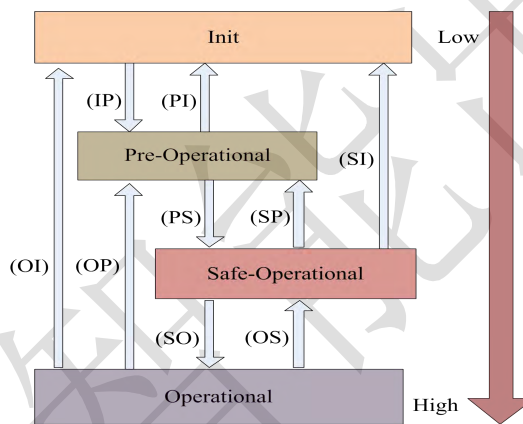
Figure 4.4: EtherCAT state machine transformation

The transformation of the EtherCAT state machine has the following characteristics:

- (1) From initialization to operation, you must follow the order of initialization > pre-operational > Safe-operational >> operational and not skip when switching from low level to high level.
- (2) For high level to low level transition, you can skip step(s).
- (3) The master station is the initiator of all state transitions, from which the slave station responds to the state requested.
- (4) If the status transition requested by the master fails, the error message is sent from the slave station to the master station.

Table 4.2: The communication function of EtherCAT state machine

State and transformations	Communication function
Init	No Communication between master and slave stations
Pre-operational	Mailbox communication is valid and no process data communication, i.e.SDO function is effective
Safe-Operational	Mailbox communication and sending process data objects are valid, i.e. SDO and TXPDO are valid

Operational	Mailbox communication, receiving and sending process, data objects are valid, namely SDO, RXPDO and TXPDO are effective
-------------	---

4.5 COE

4.5.1 COE VS CANopen DS301

COE is similar to the CANopen DS301 protocol, but has made some changes and extensions on DS301 basis. Their differences are listed in table 2.3.

Table 4.3: COE and CANopen DS301 comparison

Contrast items	COE	DS301
Field-bus	EtherCAT	CAN
Message structure	Standard Ethernet	CAN 2.0A standard
SDO data collection	SM mailbox data area	CAN message
PDO data collection	SM process data area	CAN message
Each PDO mapping length	Maximum 32 bytes *1)	Maximum 8 bytes
Communication state machine switching	0x120/0x130 register	NMT (network management tool)
Identification of communication objects	Synchronization management (SM)	COB-ID (object dictionary identification code)

*1) EM3E supports each PDO mapping 8 dictionary objects with a maximum of 32 bytes

4.5.2 EM3E network structure

The structure of the network module of the EM3E stepping system is shown in figure 4.5:

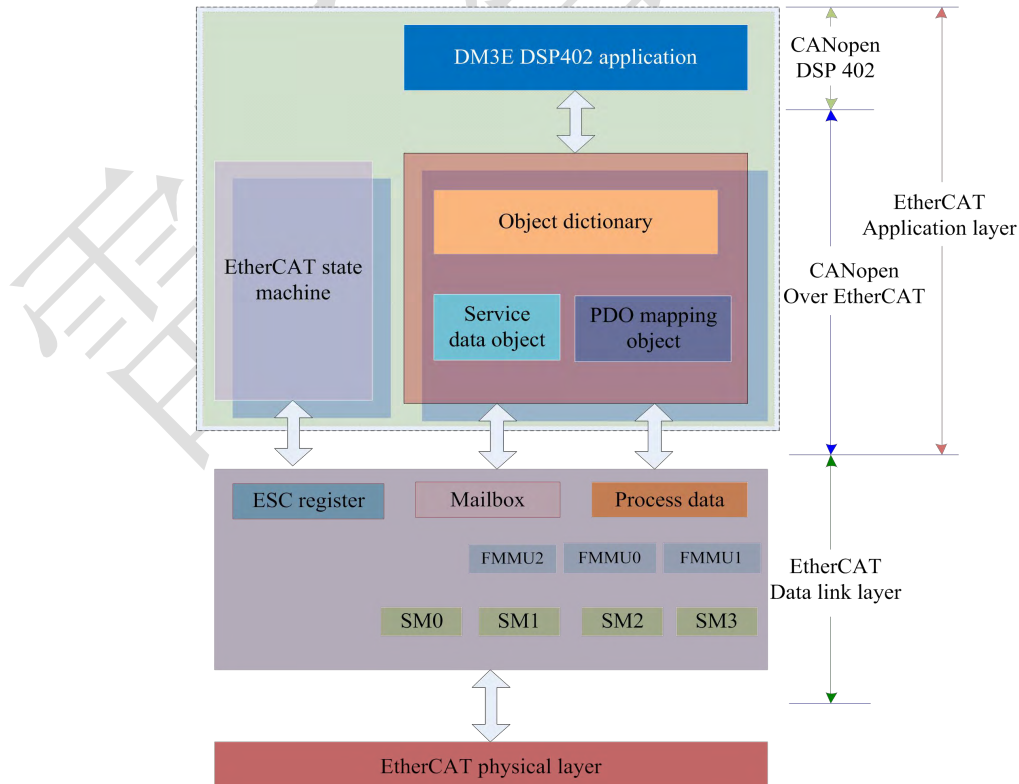

Figure 4.5: EM3E device structure

- The data link layer is mainly realized from EtherCAT station controller (ESC). The EM3EEtherCAT application layer protocol mainly includes three following parts: the application part (CANopen DSP402), the object dictionary and communication function (red grid part), of which the object dictionary and communication function can be collectively referred to as the COE.
- Core part: **Object dictionary**——the bridge between communication function and application part
- Key part: **Communication function**——Implementation of communication rules (SDO, PDO, etc.).
- Important part: **Application part**——Determines the device's specific functions, such as drives and IO modules.

4.5.3 Object dictionary

EtherCAT master controls EM3E drive by reading and writing through the parameter / equipment status information. To achieve this, the driver defines readable and writable parameters and read-only state value. Those sets of parameters and values are called the object dictionary.

The EM3E object dictionary contains all data objects related to DSP402 and CoE in a standardized manner. It is a collection of EM3E parameter data structures.

Object dictionary access interface

The EM3E object dictionary refers to the communication interface with the master station, as shown in figure 4.6.

The EtherCAT main station can implement the motion control function over EM3E, which is accomplished by the object dictionary interface.

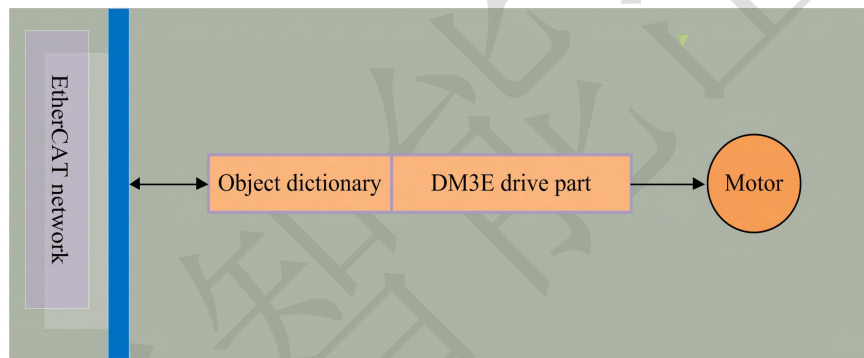

Figure 4.6: Object dictionary as access interface

Object dictionary and application layer protocol

The application layer protocols (COE and DSP402) specify a large number of mandatory objects and optional objects. For EM3E communication part (COE) to implement the interactive function with EtherCAT network, the object dictionary of communication part shall be applied. For example, the object dictionary can be configured to receive data sent by the master station; For EM3E application part to access the movement function of devices, the object dictionary of application part shall be applied. For example, the object dictionary can be configured to control the origin movement of EM3E ; All these functions are based on object dictionary interface.

Object dictionary structure and visit characteristics

Basic structure of the object dictionary as table 4.4

Table 4.4 : Object dictionary structure

Index	16bit, such as 1000h
sub-index	8bit, such as 00h、 01h
Name	-
Object type	Var, array etc.
Data type	Such as unsigned 32-bit

Visit property	Such as RO
PDO mapping	No mapping
Value range	-
Default value	-

Object dictionary visit has the following features:

- A. Assemble the way of looking up into dictionary, such as phonetic sequence method.
- B. Objects corresponding to fixed indexes and Sub-indexes are determined.
- C. The object dictionary access methods include the service data object (SDO) and the process data object (PDO)

4.5.4 Service data object (SDO)

SDO overview

The EM3E series stepping system supports the SDO service, and the EtherCAT master can configure, monitor and control the EM3E stepping system by using SDO to read and write the object dictionary of the EM3E stepping system.

The SDO adopts the client / server model; the master station corresponds to the client in the SDO operation, and the EM3E slave station is the server. all the transfers must be client initiated, then the server responds.

In traditional CANopen DS301 mode, the SDO protocol can only transmit 8 bytes at a time in order to match the data length of CAN packets. In the COE enhancement mode, only the payload data is expanded without changing the protocol header. In this way, the SDO protocol uses a mailbox with a larger data length, thereby improving the transmission efficiency of large data.

SDO protocol and message format

Currently, EM3E supports the following two SDO services:

(1) Fast transmission service:

Consistent with the CANopen DS301 protocol, it uses only 8 bytes to transmit up to 4 bytes of valid data.

(2) Conventional transmission service:

The maximum number of bytes to transmit depends on the allocated mailbox synchronization manager capacity.

SDO transport is divided into two types of download and upload, this manual is only a brief introduction to download services. For upload and more detailed information, please refer to the ETG specification (ETG1000-5 and ETG1000-6) application layer protocol section. The SDO data frame format is shown in figure 4.7.

Bits	48	16	64	Depending on mailbox manager capacity
Mapping content	Mail data header	COE data header	Standard SDC data	Extensible data

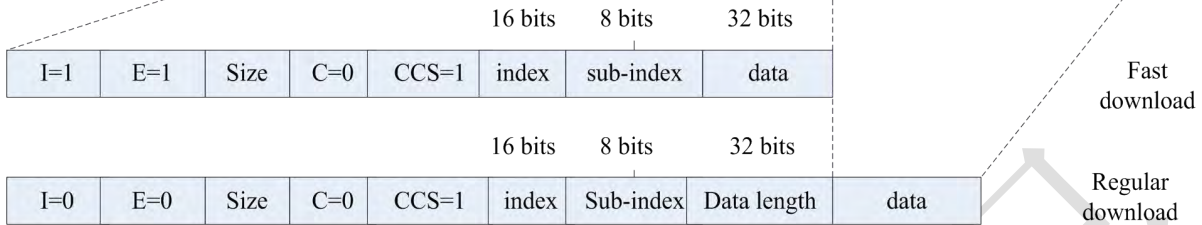

I : quantity mark
 E : transmission type
 Size: transport bytes
 C : complete visit
 CCS : command code

Figure 4.7: SDO download service data frame format

SDO download / transport/ request service data, as specified in table 4.5

Table 4.5: SDO download service data content list

Data area	Bytes	Bits	Name	Description
Mail header	2	16	Length n	$n \geq 0x0A$, COE command and SDO data length
	2	16	Address	Data original address
	1	0-5	Channel	Reserved
		6-7	Priority level	0: lowest priority 3: highest priority
	1	0-3	Type	3: COE
4-7		Reserved	-	
COE command	2	0-8	PDO code	0
		9-11	Reserved	-
		12-15	Service type	2: SDO request
SDO data	1 (control byte)	0	Quantity mark	0: Not set; 1: Set byte transmission
		1	Transmission type	0: conventional /segment transmission; 1: fast transmission
		2-3	Byte transmission	0: conventional /segment transmission invalid; others: number of byte transmission
		4	Complete	0: incomplete visit;

			visit	1: complete visit
		5-7	Command code	0: segment download request 1: download request
	2	16	Index	Object dictionary index
	1	8	sub-index	Object dictionary sub-index
	4	32	Data	Fast transmission: object dictionary data Conventional transmission: total bytes of object dictionary
	n-10	*1)	Extended data	Conventional transmission for extended data

*1) It can use conventional transmission mode as long as the length is no more than the mailbox synchronization manager settings.

After EM3E receives the SDO download request from the main station, EM3E parses its contents; if there is no error after parsing, EM3E sends the data frame of the download response to the main station; the format is shown in Figure 4.8

Bits	48	16	64	Depending on mailbox manager capacity
Mapping content	Mail data header	COE data header	Standard SDC data	Extensible data

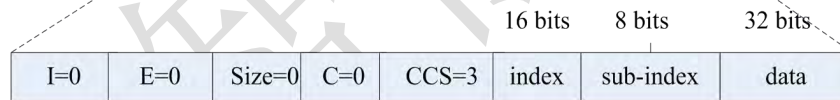

I : quantity mark
 E : transmission type
 Size: transport bytes
 C : complete visit
 CCS : command code

Figure 4.8: SDO download response data frame format

SDO download response data detailed contents are shown in table 4.6

Table 4.6: SDO download response data description

Data area	Bytes	Bits	Name	Description	
Mail header	2	16	Length n	$n \geq 0x0A$, COE command and SDO data length	
	2	16	Address	Data original address	
	1	0-5		Channel	reserved
		6-7		Priority level	0:lowest priority,...3:highest priority
	1	0-3		Type	3:COE
		4-7		Reserved	-

COE command	2	0-8	PDO code	0
		9-11	Reserved	-
		12-15	Service type	3:SDO response
SDO data	1 (control byte)	0	Quantity mark	0
		1	Transmission type	0
		2-3	Byte transmission	0
		4	Complete visit	0:incomplete visit;1:complete visit
		5-7	Command code	0:segment download request;1:download request
	2	16	Index	Object dictionary index
	1	8	sub-index	Object dictionary sub-index
	4	32	Reserved	-

Stop SDO transmission

During the SDO transmission, if an error occurs in the EM3E data analysis, the SDO can be sent to request transmission termination, and the master station will terminate the current SDO transmission after receiving the request. Table 2.7 is the data content terminated by the SDO transmission.

Table 4.7: SDO stop data transmission description

Data area	Bytes	Bits	Name	Description
Mail header	2	16	Length n	$n \geq 0x0A$, COE command and SDO data length
	2	16	Address	Data original address
	1	0-5	Channel	reserved
		6-7	Priority level	0:lowest priority,...3:highest priority
	1	0-3	Type	3:COE
4-7		Reserved	-	
COE command	2	0-8	PDO code	0
		9-11	Reserved	-
		12-15	Service type	2:SDO request
SDO data	1 (control byte)	0	Quantity mark	0
		1	Transmission type	0:conventional /segment transmission
		2-3	Byte transmission	0
		4	Reserved	-

		5-7	Command code	4:stop transmission request
	2	16	Index	Object dictionary index
	1	8	Sub-index	Object dictionary sub-index
	4	32	Stop code	Details refer to table 2.10

Table 4.7 shows the termination code of 4 bytes, which indicates the reason for the termination of the transmission, as defined specifically in table 4.8

Table 4.8: Transmission terminated code supported by EM3E SDO

Termination code	Meanings
0x05040000	SDO transmission time out
0x05040001	Command code invalid or unknown
0x05040005	Memory overflow
0x06010000	An attempt to manipulate objects that do not support access *1)
0x06010001	An attempt to read write-only objects
0x06010002	An attempt to write read-only objects
0x06020000	The accessing object does not exist
0x06040041	Object cannot be mapped to PDO
0x06040042	The length of the PDO mapping exceeds the prescribed length
0x06090011	The object sub-index does not exist
0x06090031	The input value exceeds the maximum value and is automatically set to the maximum value
0x06090032	The input value exceeds the minimum and is automatically set to the minimum
0x08000000	General error
0x08000020	Unsupported transport / save operation *2)
0x08000021	Invalid save operation *3)

*1) Currently only support the save / restore of the factory parameters, attempting to save / restore other class objects will report an error.

*2) Operate the 1010h/1011h object to save / restore parameters, and the input data does not conform to the COE specification.

4.5.5 Process data object (PDO)

PDO overview

PDO is generally used for real-time data updates. It is divided into PDO (RXPDO) and PDO (TXPDO). The data flow direction of the former is from the main station to the slave station and the latter from the slave station to the main station.

The EM3E PDO feature supports synchronous cycle refresh and also supports non periodic updates. When the master station chooses the distributed clock synchronization mode, the PDO will be updated at the same synchronization period (see Figure 2.4 for more information); if the free run mode is selected, then the update of the PDO data will be non-periodic.

PDO mapping

Through PDO mapping, real-time transmission of mapping objects can be achieved. EM3E supports 4 groups of RXPDO and 2 groups of TXPDO simultaneous transport, each PDO object can map 8 object dictionary objects (maximum length 32 bytes), PDO mapping content format, is shown in the table 4.9.

Table 4.9: PDO mapping content format

Bit	31-16	15-8	7-1
Content	Sub-index of mapped object	Sub-index of mapped object	Bit length (hexadecimal form)
Example	6040h	00h	10h (length: 16bits)

The default PDO mapping (consistent with the XML file) is shown in table 4.10.

Table 4.10: Default PDO mapping

PDO mapping object index	PDO object sub-index	Mapping content	Mapping content decomposition			Name of the mapping content
			Index	sub-index	Bit length	
RXPDO1 (1600h)	01h	60400010h	6040h	00h	10h (16 bits)	Control byte
	02h	607A0020h	607Ah	00h	20h (32 bits)	Target position
	03h	60B00020h	60B0h	00h	20h (32 bits)	Position offset
	04h	60B80010h	60B8h	00h	10h (16 bits)	Probe function
RXPDO2 (1601h)	01h	60400010h	6040h	00h	10h (16 bits)	Control byte
	02h	607A0020h	607Ah	00h	20h (32 bits)	Target position
	03h	60810020h	6081h	00h	20h (32 bits)	Max. speed
	04h	60830020h	6083h	00h	20h (32 bits)	Acceleration
	05h	60840020h	6084h	00h	20h (32 bits)	Deceleration
	06h	60600008h	6060h	00h	08h (8 bits)	Operation mode
RXPDO3 (1602h)	01h	60400010h	6040h	00h	10h (16 bits)	Control byte
	02h	60FF0020h	60FFh	00h	20h (32 bits)	Target speed
	03h	60830020h	6083h	00h	20h (32 bits)	Acceleration
	04h	60840020h	6084h	00h	20h (32 bits)	Deceleration
	06h	60600008h	6060h	00h	08h (8 bits)	Operation mode
RXPDO4 (1603h)	01h	60400010h	6040h	00h	10h (16 bits)	Control byte
	02h	60980008h	6098h	00h	08h (8 bits)	Homing method
	03h	60990120h	6099h	01h	20h (32 bits)	Homing speed (fast)
	04h	60990220h	6099h	02h	20h (32 bits)	Homing speed (slow)

	05h	609A0020h	609Ah	00h	20h (32 bits)	Homing acceleration/deceleration
	06h	607C0020h	607Ch	00h	20h (32 bits)	Homing offset
	07h	60600008h	6060h	00h	08h (8 bits)	Operation mode
TXPDO1 (1A00h)	01h	603F0020h	603Fh	00h	10h (16 bits)	Latest error code
	02h	60410010h	6041h	00h	10h (16 bits)	Status word
	03h	60610008h	6061h	00h	08h (8 bits)	Operation mode display
	04h	60640020h	6064h	00h	20h (32 bits)	Actual position
	05h	60B90008h	60B9h	00h	10h (16 bits)	Probe status
	06h	60BA0020h	60BAh	00h	20h (32 bits)	Probe 1 rising edge position
	07h	60FD0020h	60FDh	00h	20h (32 bits)	Digital input status
TXPDO2 (1A01h)	No default mapping					

PDO dynamic mapping

Unlike CIA DS301, COE uses the PDO specified object (1C12h/1C13h) to configure the PDO mapping object (1600h-1603h/1A00h-1A01h) to the PDO object synchronization manager (synchronization manager 2/3), and PDO specifies the object definition, as table 4.11.

Table 4.11: PDO specified object definition

Index	sub-index	Range	Data type	Access property
RXPDO Specified object (1C12h)	00h	0-4	U8 *1)	RO *2)
	01h	1600h-1603h	U16	RW
	02h		U16	RW
	03h		U16	RW
	04h		U16	RW
TXPDO Specified object (1C13h)	00h	0-2	U8	RO
	01h	1A00h-1A01h	U16	RW
	02h		U16	RW

*1) U stands for unsigned types, for example U8 stands for unsigned 8 bits and U16 for unsigned 16 bits.

*2) Expression of accessing properties. RO means read only, RW means readable and writable, and WO stands for writing only.

EM3E PDO dynamic mapping setting process

- A. Switch the EtherCAT state machine to pre-operational. In this state, PDO mapping can be configured by using SDO, and each state communication function can refer to the contents described in table 4.10.
- B. Clears the PDO mapping object of the PDO specified object, that is, set 1C12-00h/1C13-00h to 0.
- C. Enable the PDO mapping object. i.e. the sub-index 0 of the 1600h-1603h/1A00h-1A01h is assigned to value '0'.
- D. To reconfigure the PDO mapping contents, write the mapping objects according to table 2.11 format to an object of 1600-01h-1600-08h, 1601-01h-1601-08h, 1602-01h-1602-08h, 1603-01h-1603-08h (RXPDO mapping contents are written from 1600h-01) 1A00-01h-1A00-08h content or 1A01-01h-1A01-08h (TXPDO mapping contents are written from 1A00h.)
- E. Set the total number of PDO mapping objects to be written to 1600-00h, 1601-00h, 1602-00h, 1603-00h, 1A00-00h, or 1A01-00h. The total number of PDO mapped objects that do not have mapped content will be 0.
- F. Write valid PDO mapping objects indexes to PDO specified objects, meaning write valid RXPDO mapping object index to 1C12-01h-1C12-04h and write valid TXPDO mapping object index 1A00, 1A01h to 1C13-01h, 1C13-02h.
- G. Set the total number of PDO specified objects, i.e.writes the number of mapped objects to 1C12-00h and 1C13-00h.
- H. Convert the EtherCAT state machine to security operations or above, the configured PDO mapping will be valid.

EM3E PDO examples of dynamic mapping processes

This example uses a RXPDO to add 6081-00h (protocol position mode, maximum speed) and 6083-00h (acceleration) mapping objects in RXPDO1 as an example.

Table 4.10 shows that there are already 5 objects in RXPDO1, and this example writes 6081-00h and 6083-00h objects in table 4.9 to 1600-06h and 1600-07h.

Step B: Set 1C12-00h to 0

1C12h PDO specified object content					
Subindex	00h	01h	02h	03h	04h
Mapping content	0	—	—	—	—

Figure 4.9: Clear PDO specified object data

After the 1C12-00h is set to 0, the 1C12-01h-1C12-04h will automatically fail.

Step C: Set 1600-00h to 0

1600h mapping content combination table									
Subindex	00h	01h	02h	03h	04h	05h	06h	07h	08h
Mapping content	0	—	—	—	—	—	—	—	—

Figure 4.10: Clear PDO mapping object data

When the 1600-00h is set to 0, the mapping content in the 1600-01h-1600-08h will automatically fail.

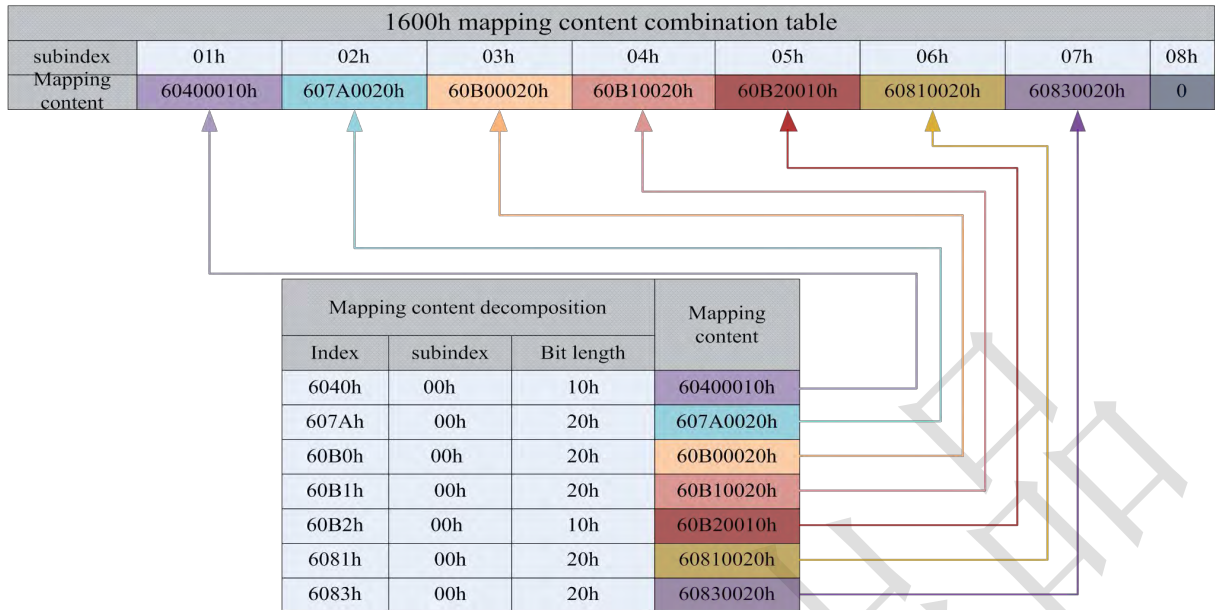
Step D: Configure the contents of 1600-01h-1600-07h

Figure 4.11: Set PDO mapping object content

Configure sub-index of object 1600h (not include sub-index 0), sub-index that has no content will be set as 0(as 1600-08h)

Step E: Write in the 1600-00h object, that is, set the total number of 1600h mapping objects.

1600h mapping content combination table									
Subindex	00h	01h	02h	03h	04h	05h	06h	07h	08h
Mapping content	7	60400010h	607A0020h	60B00020h	60B10020h	60B20010h	60810020h	60830020h	0

Figure 4.12: Set the total number of mapping objects

In this example, the 1600h object is configured with 7 mapping objects, so the 1600-00h is set to 7.

Step F: The PDO mapping object 1600h is written to 1C12-01h as content

1C12h PDO specified object content				
Subindex	01h	02h	03h	04h
Mapping content	1600h	0	0	0

Figure 4.13: Configuring PDO specified object content

This example uses only one RXPDO, so the 1600h data which will be written to 1C12-01h, and 1C12-02-1C12-04h are all 0.

Step G: Set the number of PDO mapping objects in the specified object

1C12h PDO specified object content					
subindex	00h	01h	02h	03h	04h
Mapping content	1	1600h	0	0	0

Figure 4.14: Set the number of PDO specified object

In this example, only one RXPDO mapping object 1600h is used, so the data for 1C12-00h is 1.

Note: Steps A and H are not included in this example, the specific example of appendix B corresponds to this example, and contains the simulation of step A & H.

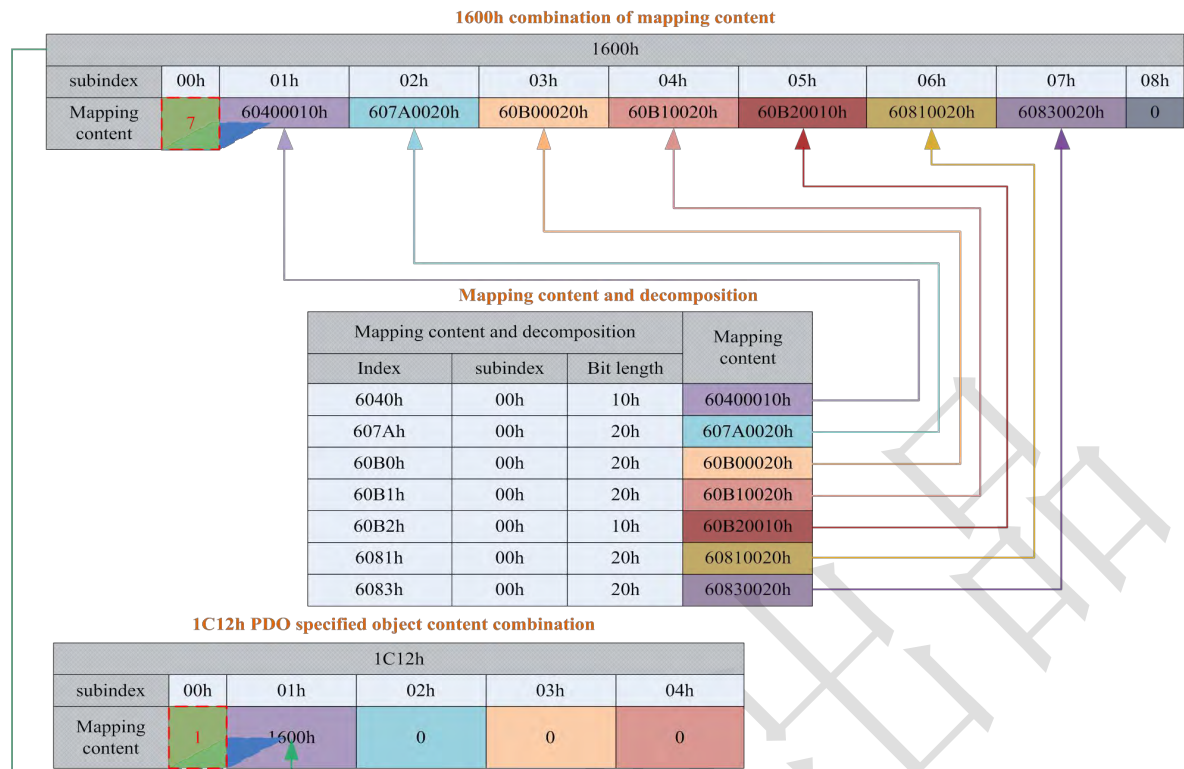

Figure 4.15: EM3E PDO dynamic mapping setting example overview

4.5.6 SDO VS PDO

The difference and relation between SDO and PDO can be summarized as table 4.12.

Table 4.12: The difference and relation between SDO and PDO

Contrast terms	PDO	SDO
Communication ability	Maximum 64 bytes	General 4 bytes (fast transmission)
Efficiency	High	Low
Priority level	High	Low
Real-time performance	Real-time(synchronous mode)	Non-real time
Transmission initiative	Active transmission	Passive transmission
Object dictionary visit	Indirect visit	Direct visit
	Visit PDO mapping object	Visit arbitrary objects
Synchronism	synchronization/Asynchronization	Asynchronization
Application situation	Real-time data transmission	Configure PDO mapping、 parameter settings

Note: the contrast terms in table 2.14 are based on EM3E stepping system and do not represent the relevant product data of other vendors.

4.5.7 Quick event

The Quick message is sent to the main station by an internal error event triggered by the EM3E drive. The internal

error contains network warnings and drive error alarms. When a warning / error occur, EM3E will embed the error code into the urgent message and send it to the main station.

The data format of the Quick message is shown in table 4.13.

Table 4.13: Quick message format

Content	Mailbox header	Command	Error code	Error register	User defined area
	Type =3(COE)	Type =1	Details 4.2	Details 4.1	*1)
Bytes	6	2	2	1	5

*1) Low 2 bytes are consistent with the error code 603Fh object contents, 3-high bytes are all 0.

4.6 Slave station alias settings and network status display.

4.6.1 Specification of network status display

EM3E can determine the network connection status according to the LED lights of the network port of the drive

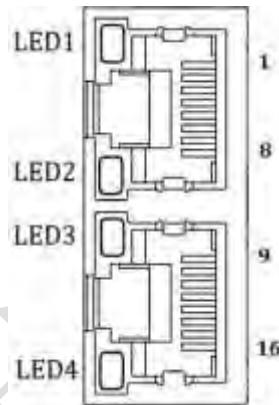

Figure 4.16: EM3E network port

- ① LED1 is “Link/Activity IN” status lamp, green.
- ② LED3 is “Link/Activity OUT” status lamp, green.
- ③ LED2 is “RUN” status lamp, green, EtherCAT state machine indicator.
- ④ LED4 is “ERR” status lamp, red, network error indicator, indicator details see [section 7.1](#).

LED display specification as table 4.14

Table 4.14: LED display specification

Name	Color	Status	Description
RUN	Green	OFF	Initialization status
		Blinking	Pre-operational status
		Single flash	Safe-operational status
		ON	Operating status
ERR	Red	OFF	See section 7.1 for details
		Blinking	

		Single flash	
		Double flash	
		Flickering	
		ON	
L/A IN	Green	OFF	Not established on physical layer link
		ON	Established on physical layer link
		Flickering	After the link is established, the interactive data
L/A OUT	Green	OFF	Not established on physical layer link
		ON	Established on physical layer link
		Flickering	After the link is established, the interactive data

Indicator lamp state description as figure 4.17

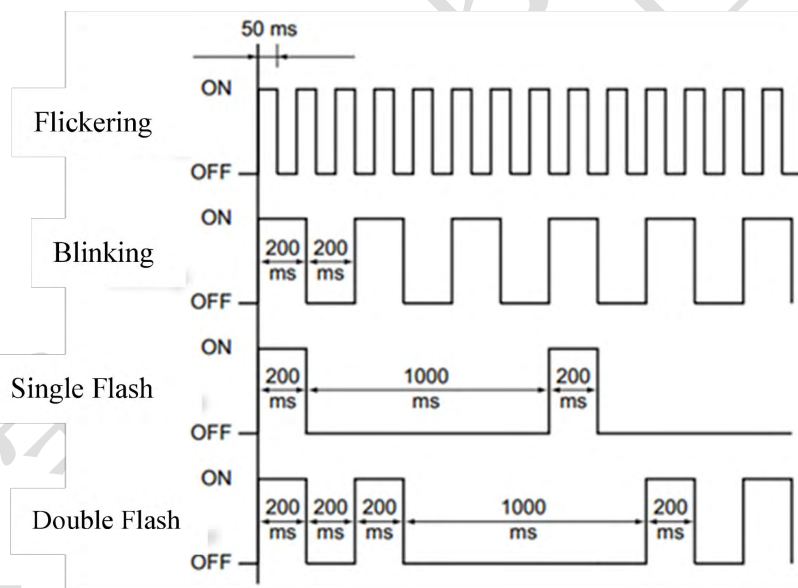

Figure 4.17: LED indicator lamp state

4.7 Parameters saving

EM3E supports the saving function of the vendor parameters. After modifying the parameters, the 0x1010 object can be saved by the master operation.

The master station can operate 0x1010-04 to save user parameters to EEPROM, if the driver detects that the 0x1010-04 data sent by master is 0x65766173, the driver will save current parameters to EEPROM (including all parameters that have saving property from 0x2000 to 0x5FFF).

Note: do not turn off the power during the EEPROM writing operation; otherwise false data might be written; if this happens, reset all parameters before enter the EEPROM writing operation.

4.8 Restore factory parameters

The master station can operate 0x1011-04 to restore the factory user parameters. If the drive detects that the data of the 0x1010-04 sent by the master is 0x64616f6c, the drive will be restored to factory default.

5 EM3E CiA 402 Control Introduction

5.1 EM3E Stepper System Control Motion Steps

Table 5.1 Sequence of EM3E stepper system motion steps

Sequence	Action Meaning
1	EtherCAT master station sends Control word (6040h) to initialize EM3E stepper drives
2	EM3E stepper drives send feedback status word (6041h) to EtherCAT master station for getting ready
3	EtherCAT master station sends Enable command (control word transition) to drives, refer to section 5.2
4	EM3E stepper drives get Enable and feedback the state to EtherCAT master
5	EtherCAT master station sends Homing command (homing related object and control word transition). If using internal homing methods of EM3E stepper drives, refer details to homing modes in section 5.5.3
6	EM3E stepper drives complete homing and feedback the state to EtherCAT master
7	EtherCAT master station sends position/velocity command (operation mode related parameters and Control word transition), refer to operation modes in section 5.5
8	EM3E stepper drives complete motion action and feedback the actual position/velocity to EtherCAT master
9	EtherCAT master station sends command for the following motion

5.2 402 State Control and Transition

5.2.1 State Transition Diagram

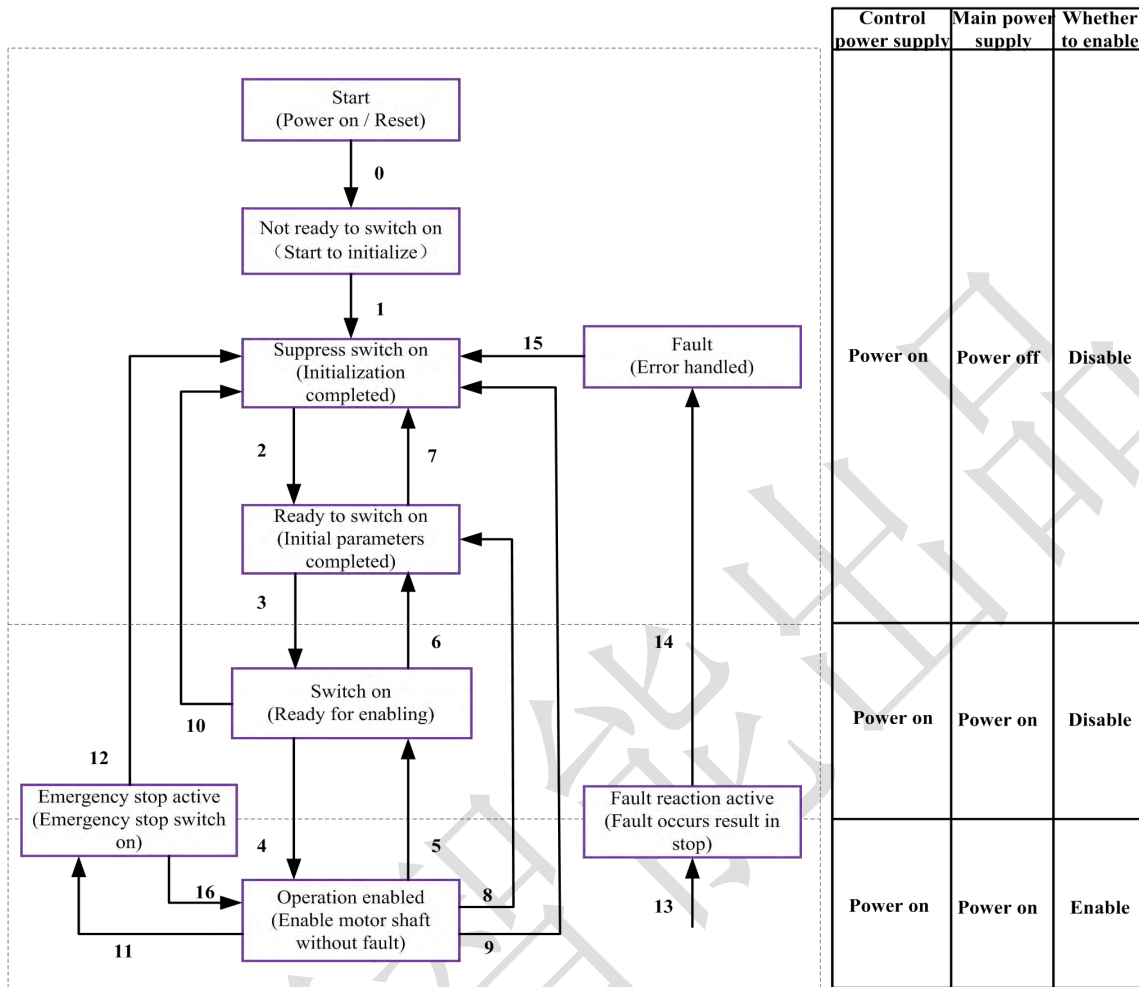

Figure 5.1 EM3E series 402 state machines

The drive's actions corresponding to the drive status in above figure are in the table as below:

Table 5.2 Drive actions corresponding different status

States	EM3E EtherCAT stepper drive actions
Not ready to switch on	The drive is powered on and starts to initialize. The motor is disabled; if the motor is with brake, it will be locked by brake
Suppress switch on	Initialization completed and start to initial parameters, no fault, motor is disabled
Ready to switch on	Complete parameters initialization, motor is disabled
Switch on	Drive is ready to enable
Operation enable	The motor is enabled, no fault.
Quick stop active	Quick stop switch on
Fault reaction active	Fault occurred and unhandled, which result in drive stop and disable
Fault	Fault is handled, ready to convert the 402 state machine from 'Fault' to 'Switch on disabled', motor is disabled.

The transition of 402 state machines is completed by the control word (6040h) of EM3E stepper system and status word can indicate every state of the transition.

The conditions of status transition (control word trigger) and corresponding action (Status word transition) are shown as the following table

Table 5.3 States transition

402 State transition		Trigger condition	6040h Value *1)	Action	6041h State*2)
0	Start →Not ready to switch on	Control power supply switch on/auto-transition after reset	Auto-transition after power on, no need control command	Drive self-test and initialization	0000h
1	Not ready to switch on →Suppress switch on	Auto-transition after complete initialization	No command/0000h	Communication state pre-operation or above *3)	×250h
2	Suppress switch on →Ready to switch on	Receive the command of power off *4)	0006h	Parameters initializing	×231h
3	Ready to switch on →Switch on	Receive the command of switch on	0007h	Turn on main power supply, wait for enable	×233h
4	Switch on →Operation enable	Receive the command of operation enable	000Fh	Operation enable	×237h
5	Operation enable →Switch on	Receive the command of disabled operation	0007h	Disabled operation	×233h
6	Switch on →Ready to switch on	Receive the command of turn off main power supply	0006h	Turn off main power supply, control power supply is still on	×231h
7	Ready to switch on →Suppress switch on	Receive the command of disable voltage output	0000h	No action	×270h
8	Operation enable →Ready to switch on	Receive the command of control power supply	0006h	Disable operation, turn off main power supply	×231h
9	Operation enable →Suppress switch on	Receive the command of disable voltage output	0000h	Disable operation and turn off main power supply	×270h
10	Switch on →Suppress switch on	Receive the command of disable voltage output	0000h	Turn off main power supply, control power supply is still on	×270h
11	Operation enable →Quick stop active	Receive the command of quick stop	0002h	Enable quick stop	×317h
12	Quick stop active →Suppress switch on	Receive the command of disable voltage output	0000h	Disable operation and turn off main power supply	×350h
13	→Fault reaction active	EM3E detects errors occur	Drive automatically switches Stop error	Stop error occur, wait for processing	×23Fh
14	Fault reaction active →Fault	Automatic switching	No command	Disable operation, and turn off main	×218h

				power supply	
15	Fault → Suppress switch on	Receive the command of alarm restore	0080h	After processing this error, then execute restore drive.	×270h

×: It means that not affected by the state of this bit.

*1) The value of (6040h) is only as a recommended command.

*2) The value of (6041h) is the state corresponding to the (6040h).

*3) The communication state is referred to ESM state machines

*4) The command of turning off power supply is a command name, not the physical action of turning off power supply.

5.2.2 CIA DSP402 control word

Control word (6040h) is defined as shown in the following table.

Table 5.4 control word (6040h) bit definition

Bit	15-9	8	7	6-4	3	2	1	0
Definition	invalid	suspend	Wrong reset	Depend on operating mode	Operation enable	Quick stop	Output voltage	Switch on

Transition commands that can be triggered by combination of bit 7 and bit 3-0 is shown in the following table.

Table 5.5 Transition commands of Bit 7 and bit 3-0 combination

Transition command	bit 7 and bit 3-0					6040h Typical value	402 state machines transition *3)
	7: Fault reset	3: Operation enable	2: Quick stop	1: Enable voltage output	0: Switch on		
Shutdown	0	x	1	1	0	0006h	2, 6, 8
Switch on	0	0	1	1	1	0007h	3+4*1)
Switch on + enable operation	0	1	1	1	1	000Fh	3*
Disable voltage output	0	x	x	0	x	0000h	7;9;10;12
Quick stop	0	x	0 *2)	1	x	0002h	7;10;11
Disable operation	0	0	1	1	1	0007h	5
Enable operation	0	1	1	1	1	000Fh	4;16
Fault reset	Rising edge	x	x	x	x	0080h	15

×: It means that not affected by the state of this bit.

*: The drive executes this transition command during Switched on state.

*1) Move to Operation enabled state after Switched on state.

*2) Quick stop triggering logic is valid when the value is 0, pay attention to the difference with other triggering

logic.

*3) Please refer to figure 5.1 for transition conditions.

The state in different operation mode is indicated by the combination of bit 8 and bit 6-4 in the control word (6040h), as shown in the following table.

Table 5.6 Bit8 and bit 6-4 in different operation mode

bit	Operation mode			
	PP mode	PV mode	HM mode	CSP mode
8	Deceleration stop	Deceleration stop	Deceleration stop	x
6	Absolutely/Relatively	x	x	x
5	Triggered immediately	x	x	x
4	New location point	x	Switch on motion	x

5.2.3 CIA DSP402status word

Status word (6041h) is defined as shown in the following table.

Table 5.7status word Definition

Bit	Definition
15-14	Depend on operation mode
13-12	Depend on operation mode
11	Limit switch effective
10	Depend on operation mode
9	Remote
8	Depend on operation mode
7	Reserved
6	Switch on disabled
5	Quick stop
4	Enable voltage output
3	Fault
2	Enable operation
1	Switch on
0	Ready to switch on

State is indicated by the combination of bit 6, bit 5 and bit 3-0 in Status word (6041h), as shown in the following table.

Table 5.8 Bit6, bit 5 and bit 3-0

Bit6, bit 5 and bit 3-0	6041h typical value *1)	State of state machine	State of EM3 stepper drives
-------------------------	----------------------------	---------------------------	-----------------------------

xxxx,xxxx,x0xx,0000 b	xx00h	Not ready to switch on	The control circuit power supply is turned ON and initialization is being executed.
xxxx,xxxx,x1xx,0000 b	xx40h	Switch on disabled	Initialization has been completed. EM3E drive parameters initialized.
xxxx,xxxx,x01x,0001 b	xx21h	Ready to switch on	Parameters initialization has been completed.
xxxx,xxxx,x01x,0011 b	xx23h	Switched on	The main circuit power supply is ON. EM3E drive parameters can be set.
xxxx,xxxx,x01x,0111 b	xx27h	Operation enabled	The drive is enabled, without fault.
xxxx,xxxx,x00x,0111 b	xx07h	Quick stop active	Quick stop is executed
xxxx,xxxx,x0xx,1111 b	xx0Fh	Fault reaction active	There is an error in the EM3E drive and the cause isn't processed.
xxxx,xxxx,x0xx,1000 b	xx08h	Fault	The error was processed, wait for state transition

x: It means that not affected by the state of this bit.

*1) Only the typical values of status word (6041h) are presented with only necessary bits being configured; user can also set other bits.

Additional descriptions:

When the main circuit power supply is ON, bit 4 will be turned on.

The quick stop will be active when the bit 5 is logic '0'. Pay attention to that the activated logic is contrary to other bits

When the state machines ([section 5.2.1](#)) is in initialization or pre-operation state, bit 9 is 0 and the command in control word (6040h) can't be executed.

Bit 11 will be turned on when the hardware limit switch is activated.

Other bits in different operation modes have different meaning, as shown in the following table.

Table 5.9 Bit 15-12 and bit 8 in different operation mode

Bit	Operation mode			
	PP mode	PV mode	HM mode	CSP mode
15	Can trigger responses	x	Can trigger responses	x
14	At least one parameter value is 0	At least one parameter value is 0	At least one parameter value is 0	x
13	x	x	Fault in looking for origin	x
12	New location point response	Velocity is 0 *1)	Homing completed	Following is enable
10	Position arrived	Velocity arrived	Position arrived	x
8	Abnormal stop	Quick stop	Abnormal stop	Abnormal stop

Bit 8 mapping abnormal stop is valid under hardware limit switch, deceleration stop and quick stop triggered status.

In CSP mode, bit 12 follows the state of master station and become invalid when the drive is in disabled state or bit 12 do not respond the instruction of master station.

*1) In PV mode, bit 12 is valid when the deceleration stop or hardware limit switch is active.

5.3 Control Modes Setting

5.3.1 Supported operation modes object (6502h)

This object applies for operation modes supported by current EM3E stepping system software, the bit definition is shown as the following table.

Table 5.10 Bits definition of 6502h

Bit	31-10	9	8	7	6	5	4	3	2	1	0
Modes	Reserved	Reserved	Reserved	CSP	Reserved	HM	Reserved	Reserved	PV	Reserved	PP
Data	0	0	1	1	0	1	0	0	1	0	1
	Full name						Abbreviation				
	Profile position mode						PP				
	Profile velocity mode						PV				
	Homing mode						HM				
	Cyclic synchronous position mode						CSP				

5.3.2 Operation Mode Object (6060h) and Operation Mode Display Object (6061h)

The object (6060h) is used to set operation mode and object (6061h) is to display whether the current mode is executed by EM3E. The bits definitions of these two objects are same, as shown in the following table.

Table 5.11 6060h/6061h Data Meaning

Data	Full name	Abbreviation
1	Profile position mode	PP
3	Profile velocity mode	PV
6	Homing mode	HM
8	Cyclic synchronous position mode	CSP

5.3.3 Notes

- (1) Changing the object data of 6060h can switch between operation modes.
- (2) Object 6061h can be used to confirm current operating mode of EM3E.
- (3) When switching between different operation modes, it may need to change the mapping objects of RXPDO and TXPDO; please refer to [section 4.5.5](#).
- (4) After enable the EM3E drives, the 402 state machines won't transit if the current operation mode is not supported in this software version.

5.4 Common Functions in different operation modes

5.4.1 Digital Input / Output

Digital Input Setting

The object dictionary(2152h), (2053h) and (2154h) indicate digital input/output functions setting, filter time

setting and polarities setting respectively, as shown in the following table, please refer to [section 3.4.1](#)

Table 5.12 Digital input parameters setting

Parameter Address	Name	Access	Default Value	Range	Description
Index + sub-index					
2152+01	Digital input 1 function	R/W/S	32	0-32768	1: homing signal 2: positive limit 4: negative limit 8: emergency stop 16: user-defined 32: touch probe1 64: touch probe2
2152+02	Digital input 2 function	R/W/S	1	0-32768	1: homing signal 2: positive limit 4: negative limit 8: emergency stop 16: user-defined 32: touch probe1 64: touch probe2
2152+03	Digital input 3 function	R/W/S	2	0-32768	1: homing signal 2: positive limit 4: negative limit 8: emergency stop 16: user-defined 32: touch probe1 64: touch probe2
2152+04	Digital input 4 function	R/W/S	4	0-32768	1: homing signal 2: positive limit 4: negative limit 8: emergency stop 16: user-defined 32: touch probe1 64: touch probe2
2152+05	Digital input 5 function	R/W/S	16	0-32768	1: homing signal 2: positive limit 4: negative limit 8: emergency stop 16: user-defined 32: touch probe1 64: touch probe2

2153+01	Digital input 1 filter time	R/W/S	1000	50-60000	unit:us	Note: Too large filter time may cause time delay of control command
2153+02	Digital input 2 filter time	R/W/S	1000	50-60000	unit:us	
2153+03	Digital input 3 filter time	R/W/S	1000	50-60000	unit:us	
2153+04	Digital input 4 filter time	R/W/S	1000	50-60000	unit:us	
2153+05	Digital input 5 filter time	R/W/S	1000	50-60000	unit:us	
2154+00	Digital input active level configuration	R/W/S	0	0-65535	0: active low level (in default) 1: active high level(bit0 mapping digital input1, and so on), bit0 to bit4 mapping I1 to I5	

Digital input active level state

EM3E has two methods to set digital input active level state.

Method 1: Physical state setting

Physical state setting uses the bit 4-0 of object (2155h) to indicate physical status of digital input I5-I0, the definitions are shown as the following table.

Table 5.13 Physical state of 2155h

Bit	15-6	4	3	2	1	0
Definition	Invalid	0: IN5 invalid 1: IN5 valid	0: IN4 invalid 1: IN4 valid	0: IN3 invalid 1: IN3 valid	0: I2 invalid 1: I2 valid	0: I1 invalid 1: I1 valid

Method 2: Function status indication

EM3E has offered a mapping method of IO input function status, in which object 60FDh is the standard input IO status mapping object that conforms to standard IEC61800-200. The bits definition is shown as the following table.

Table 5.14 60FDh bit definition

Bit	I/O mapping
0	Sin state of negative limit
1	Sin state of positive limit
2	Sin state of home signal
3	Sin state of quick stop
4-16	Reserved
17	I1 input state by user defined
18	I2 input state by user defined

19	I3 input state by user defined
20	I4 input state by user defined
21	I5 input state by user defined
22	Reserved
23	Reserved
24	Reserved
25	Reserved
26	Probe 1 state
27	Probe 2 state
28-31	Reserved

Digital output setting

The object dictionary(2005h) and (2008h) indicate digital output functions setting and polarities setting respectively, as shown in the following table.

Table 5.15 Digital output parameters setting

Parameter Address	Name	Access	Default Value	Range	Description
Index + sub-index					
2005+01	Digital output 1 function	R/W/S	1	1-16	1: alarm output 4: in-position output 8: brake output 16: master station control
2005+02	Digital output 2 function	R/W/S	8	1-16	1: alarm output 4: in-position output 8: brake output 16: master station control
2008+00	Digital output level	R/W/S	0	0-3	0: positive logic 1: negative logic bit0 is mapping digital output1, and so on

Digital output function of master control

When EM3E series drives' digital outputs is set to master station control function, please refer to [section 3.4.2](#).

5.4.2 Rotation Direction Setting

The parameter related rotation direction setting is shown as following table.

Table 5.16 Rotation direction setting

Operation mode		Object dictionary	Description
Position mode	PP	2051h	0: Keep the motor direction 1: Reverse the motor direction
	HM		
	CSP		
Velocity mode	PV		

Note: The setting of positive and negative rotation is in terms of target position, not for clockwise and counterclockwise.

5.4.3 Stop Mode Setting

There are two kinds of stop modes which are quick stop and deceleration stop for EM3E series stepper drive.

- (1) If object (6085h) is set to value '0', the EM3E drive will execute quick stop, and if not, the EM3 drive will execute deceleration stop with the deceleration velocity value of object (6085h)
- (2) The stop command in limit switch state stops quickly with a maximum limit current.
- (3) If the bit 8 (Halt) of object (6040h) is to set value '1', the drive will execute deceleration stop with the deceleration velocity value of object (6084h).

5.4.4 Limit Switch

Limit switch in EM3E series stepper drive is hardware limit switch, which mainly use external digital signal to limit the motor motion range.

It is available for all the operation modes.

5.5 Operation Modes

The meaning of the corresponding abbreviations:

Abbr.	Meaning
P	Pulse number
Uint	Instruction unit
Uint/S ²	Acceleration/Deceleration unit,
RPM	Revolutions per minute
Uint/S	Instruction unit per second
rev	Revolution

The Operation modes include position mode and velocity mode.

Position Mode is a point-to-point operating mode via execution related command sending by EtherCAT master; consist of profile position (PP), cyclic synchronous position mode (CSP) and homing mode (HM).

Velocity Mode is a relative simple operating mode via execution related command sending by EtherCAT master, include profile velocity mode (PV).

5.5.1 Position Mode—PP Mode

Description

Profile Position control mode is general point to point operation, to move to target position of Target position (607Ah) object with receipt of control word (6040h) input, need to set Profile Position Mode at operation mode object (6060h). The Operation Mode Display object (6061h) is shown as Profile Position Mode. The track plan is

created by EM3E drives, and the control block diagram is shown as following figure.

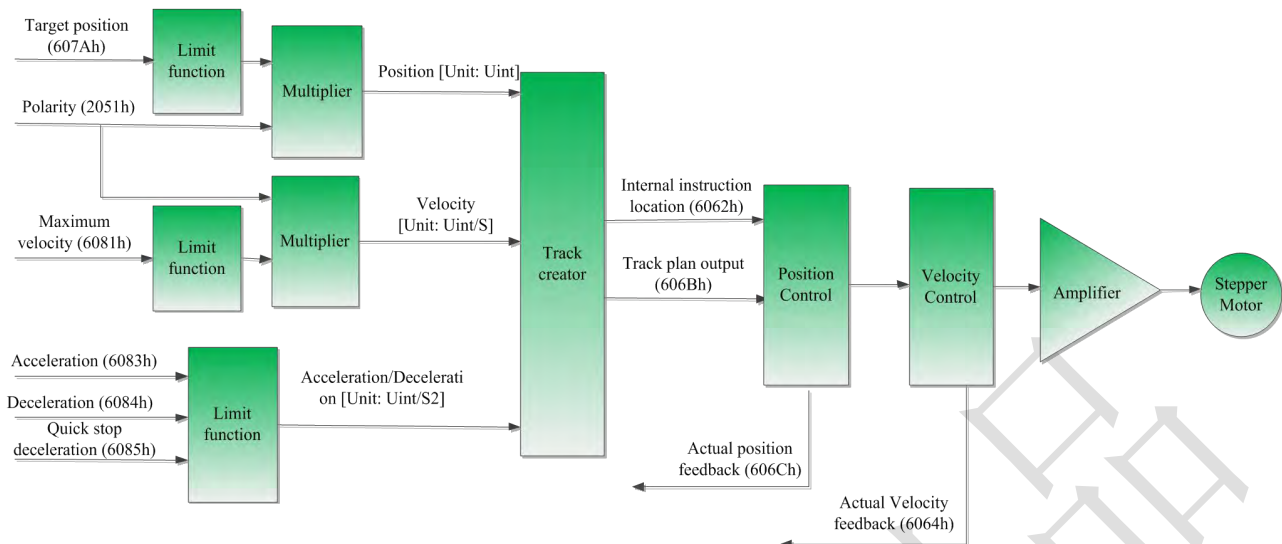

Figure 5.2 PP Mode control block diagram

Related objects

Main related objects as below:

Table 5.17 Main related in PP mode

Data Direction *1)	Object	Description	Value	Unit
Output	6060h	Operation Mode	1	-
	6040h	control word	User Defined	-
	607Ah	Target Position	User Defined	Unit
	6081h	Maximum Velocity	User Defined	Unit/S
	6083h	Profile Acceleration	User Defined	Unit/S ²
	6084h	Profile Deceleration	User Defined	Unit/S ²
	6085h	Quick stop deceleration, due to the value of 605Ah	User Defined	Unit/S ²
	605Ah	Enable the quick stop deceleration (5: Yes; Others: No)	User Defined	-
Input	2000h	Pulses for motor turning one round	User Defined	P
	6041h	Status word	Read only	-
	6064h	Actual Position Feedback	Read only	Unit
	606Ch	Actual Velocity Feedback	Read only	Unit/S
	603Fh	Recently error code	Read only	-
	6061h	Operation mode display	Read only	-

*1) The data transmission direction regards the master station as reference, “Output” means the data output from master station to EM3E Drives, “Input” means the data from EM3E drives to master station.

control word and status word

In PP Mode, the bits 6-4 of control word (6040h) are shown in following table.

Table 5.18 Bits 6-4 of control word (6040h) in PP mode

Bit (Name)	Value	Description
Bit4 (new location)	0 → 1	Start position motion with new target location (607Ah), maximum velocity (6081h), acceleration/ deceleration (6083h/6084h)
Bit5 (trigger immediately)	0	Complete current position motion to trigger a new position motion
	1	Interrupt current position motion, and start a new position motion immediately
Bit6 (absolutely / relatively)	0	Process target position (607Ah) as absolute position
	1	Process target position (607Ah) as relative position

The action models of bit5 of control word (6040h) in PP mode are shown as following table.

Table 5.19 Action models of bit5 of control word (6040h)

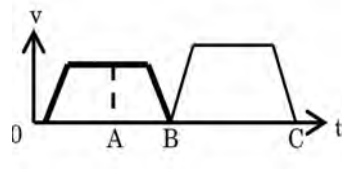
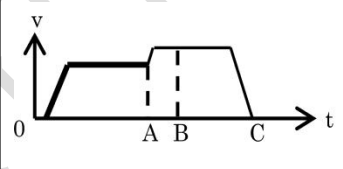
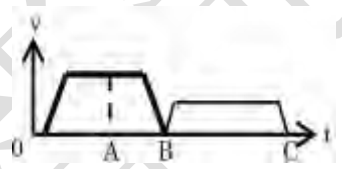
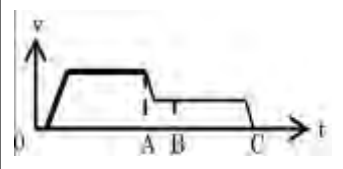
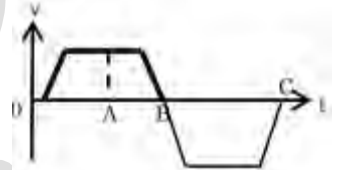
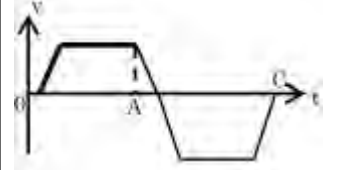
Bit5 of control word	0	1
Update target location in the direction of acceleration/uniform velocity period		
Update target location in the direction of deceleration velocity period		
Update target position with a reverse direction		

A: Changing time of master station commands

B: Arrival time of target position (before update)

C: Arrival time of target position (after update)

Thick line: Act under commands before update

Fine line: Act under commands after update

In PP Mode, definition of bits 15-12, 10, 8 of status word (6041h) is shown as the following table.

Table 5.20 Bits 15-12, 10, 8 of status word (6041h) in PP Mode

Bit (Name)	Value	Description
Bit 8 (abnormal stop)	0	Normal motion
	1	Trigger by abnormal stop, motor will stop *1)
Bit 10 (position reached)	0	Motion continued

	1	Target position reached
Bit 12 (new location response)	0	Current motion completed/ interruptible, new target location can be updated
	1	When current motion uncompleted/uninterruptible, it can not update new target position
Bit 14 (motion parameters are value 0)	0	Motion parameters are available, and all necessary parameters are not value 0
	1	At least one of necessary parameters such as maximum velocity (6081h), acceleration (6083h) and deceleration (6084h) is value 0
Bit 15 (response that can be triggered)	0	When current motion uncompleted/uninterruptible, it can not update a new target position *3)
	1	When current motion completed/interruptible, it can update new target position

*1) Bit8 abnormal stop is available in the triggered states of hardware limit switch, deceleration stop and quick stop

*2) Bit 12 of status word (6041h) will reset if the bit 4 of control word (6040h) is available trigger and bit 5 of (6040h) is invalid trigger (for example 6040h is 0x2F/4F), it can be interrupted, the action refer to table 5.19

*3) The logic of bit 5 and bit 12 have the opposite meaning in PP mode.

5.5.2 Position Mode—CSP Mode

Description

Cyclic Synchronous Position mode (CSP Mode) assigns target position to EM3E drives by Master's operation profile creation function through cyclic communication. Drives immediately execute position/velocity control with receipt of target position in each cycle.0

The supported synchronizing cycles are: 250us, 500us, 750us, 1000us, 2000us and 4000us.

The control block diagram of CSP mode is shown as the following figure

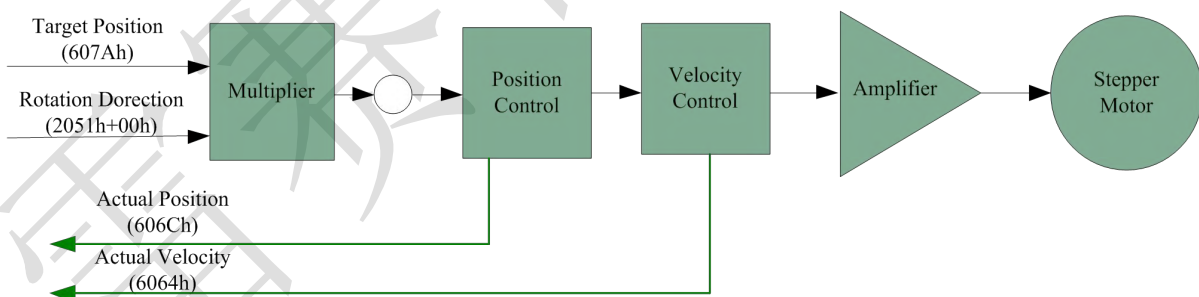

Figure 5.3 CSP Mode Diagram

Related objects

To use CSP Mode, Operation Mode object (6060h) needs to be set to value “8”. Operation Mode Display object (6061h) is shown as CSP mode, Target position Object (607Ah) transmitted from master, then target position is executed.

Table 5.21 Main related objects in CSP mode

Data Direction *1)	Object	Description	Value	Unit
Output	6060h	Operation Mode	8	-

	6040h	control word	User Defined	-
	607Ah	Target Position	User Defined	Unit
	2000h	Pulse for motor turning one round	User Defined	P
	60B0h	Position offset	User Defined	-
	6085h	Quick stop deceleration, due to the value of 605Ah	User Defined	Unit/S ²
	605Ah	Enable the quick stop deceleration (5: Yes; Others: No)	User Defined	-
Input	6041h	Status word	Read only	-
	6064h	Actual Position Feedback	Read only	Unit
	606Ch	Actual Velocity Feedback	Read only	Unit/S
	603Fh	Recently error code	Read only	-
	6061h	Operation mode display	Read only	-

*1) The data transmission direction regards the master station as reference, “Output” means the data output from master station to EM3E Drives, “Input” means the data output from EM3E drives to master station.

Control word and status word

In CSP mode, the bit 6-4 of control word (6040h) are invalid present in table 5.6, and user can operate refer to table 5.5.

The bit 15-12 of status word (6041h) are shown in table 5.9

Software Limitation (EM3E series doesn't have this feature)

Description: Using software command to limit the motion range of motor.

Application Range: Be only valid to absolute motion in CSP and PP modes.

Method: Set the object 607D-01h as the maximum value of negative direction, set the object 607D-02h as the maximum value of positive direction, the unit is in accordance with position instructions. The setting can't be saved in EM3E series EtherCAT drives at present.

Pulses per Revolution/Electronic Gear

EM3E Series no need to set electronic gear, but to set the value of pulses per revolution (2001h), the range is 6400-51200.

Position Command Filter

This feature can make the position instructions smoother and provide more reliable motion.

Address	Name	Access	Default Value	Range	Description
2009+00	FIR Enable	R/WS	0	0/1	0: No 1: Yes
2010+01	FIR Time	R/WS	1000	50-25600	Unit: us

When enable the feature of filter, it will smooth the command wave, for example if the target velocity V_c is square wave, it will be processed to trapezoidal wave after filter, which is shown as below:

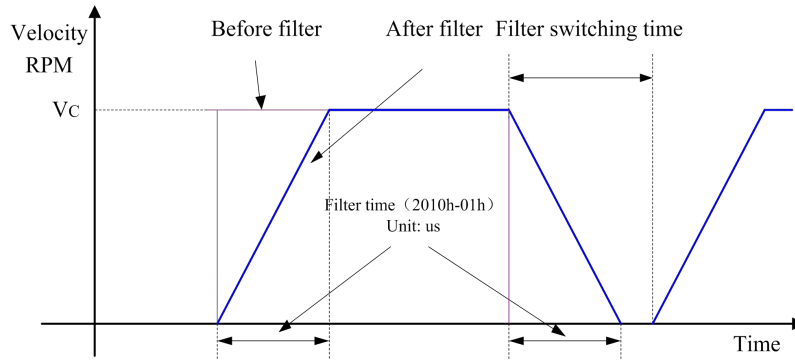

Figure 5.4 Filtering effect for square wave command

If the target velocity V_c is trapezoidal wave, it will be processed to ‘S’ wave after filter, which is shown as below:

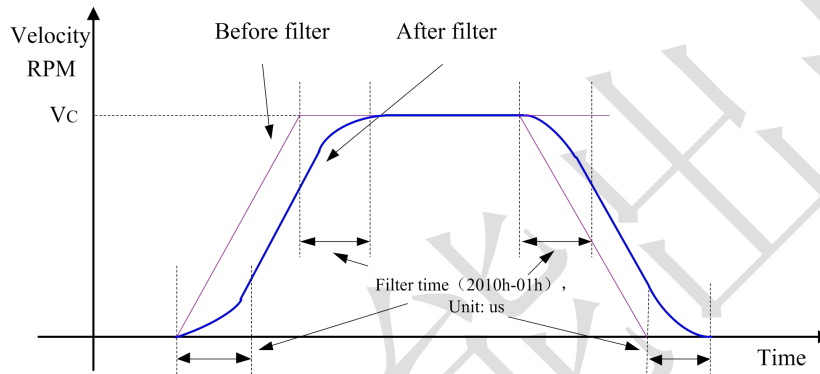

Figure 5.5 Filtering effect for trapezoidal wave command

Note: Prevent to modify this value when the motor is running.

5.5.3 Position Mode—HM Mode

Description

Origin search mode is the way of heading to origin with command of control word (6040h). To use origin search mode, you need to set Homing Mode at object (6060h) being able to origin search command once Mode of operation display (6061 h) indicates Homing Mode. The homing methods refer to [Appendix B](#)

Related objects

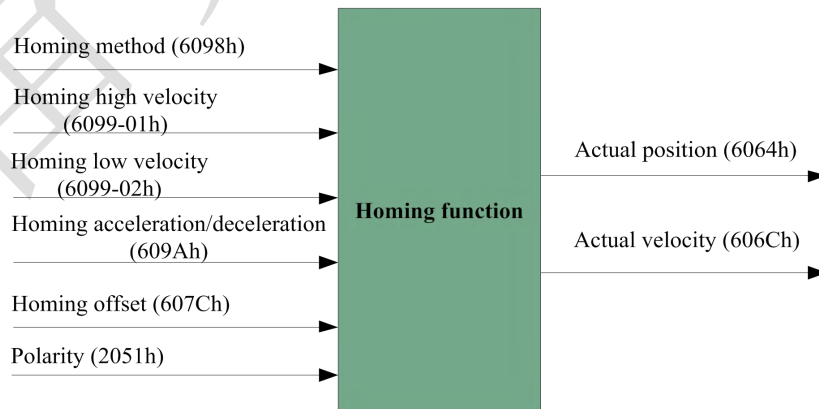

Figure 5.6 Homing mode related object

Table 5.22 Objects Main related in HM mode

Data Direction *1)	Object	Description	Value	Unit
Input	6060h	Operation Mode	6	-
	6040h	Control Word	User Defined	-
	6098h	Homing Method	User Defined	-
	6099-01h	Homing high velocity (search for limit switch)	User Defined	Unit/S
	6099-02h	Homing low velocity (search for origin signal)	User Defined	Unit/S
	609A-00h	Homing Acceleration/Deceleration	User Defined	Unit/S
	607C+00h	Homing Offset	User Defined	P
Output	6041h	Status word	Read only	-
	6064h	Actual Position Feedback	Read only	Unit
	606Ch	Actual Velocity Feedback	Read only	Unit/S
	603Fh	Recently error code	Read only	-
	6061h	Operation mode display	Read only	-

*1) The data transmission direction regards the master station as reference, “Output” means the data output from master station to EM3E Drives, “Input” means the data output from EM3E drives to master station.

Control word and status word

In HM Mode, bits 6-4 of control word (6040h) are shown as the following table.

Table 5.23 Bits 6-4 of (6040h) in HM Mode

Bit (Name)	Value	Description
Bit 4(homing motion start/suspend)	0 →1	Start homing motion
	1 →0	Suspend homing motion, the motor stop immediately
Bit 5(undefined)	0	-
	1	-
Bit 6(undefined)	0	-
	1	-

In HM Mode, bits 15-12, 10, 8 of status word (6041h) are shown as the following table.

Table 5.24 Bits 15-12, 10, 8 of (6041h) in HM Mode

Bit (Name)	Value	Description
Bit 8 (abnormal stop)	0	Normal motion
	1	Trigger by abnormal stop, motor will stop *1)
Bit 10 (position reached)	0	Motion continued

	1	Target position reached
Bit 12 (Homing completed)	0	Homing continued
	1	Homing completed, bit 12 will be available when the target position is reached *2)
Bit 14(motion parameters are value 0)	0	Motion parameters are available, all necessary parameters are not value 0
	1	At least one of necessary parameters such as homing method (6098h), homing high velocity (6099h-01), homing low velocity (6099h-02) and homing acceleration (609Ah) is value 0
Bit 15(response that can be triggered)	0	Homing motion is triggered/completed *3)
	1	Homing motion that can be triggered

*1) Bit8 abnormal stop is valid in the triggered states of hardware limit switch, deceleration stop and quick stop

*2) Detect if bit 10/12 are all set to judge homing motion is completed or not.

*3) Be used to indicate that homing motion is or can be triggered.

5.5.4 Velocity Mode—PV Mode

Description

Velocity Mode is a relatively simple operating mode via execution related command sent by EtherCAT master, include profile velocity mode (PV).

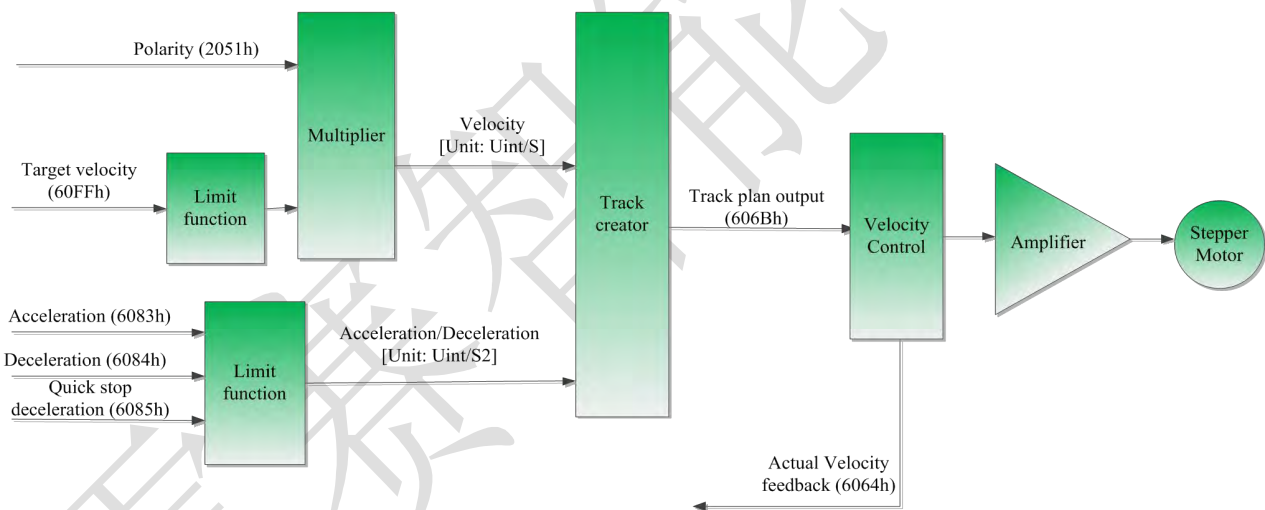

Figure 5.7 PV mode control block diagram

Related objects

Table 5.25 Main related objects in PV mode

Data Direction *1)	Object	Description	Value	Unit
Input	6060H	Operation Mode	3	-
	6040H	control word	User Defined	-
	60FFH	Profile Velocity in PV Mode	User Defined	Unit/S
	6083+00H	Profile Acceleration	User Defined	Unit/S ²
	6084+00H	Profile Deceleration	User Defined	Unit/S ²

Output	6041h	Status word	Read only	-
	6064h	Actual Position Feedback	Read only	Unit
	606Ch	Actual Velocity Feedback	Read only	Unit/S

*1) The data transmission direction regards the master station as reference, “Output” means the data output from master station to EM3E Drives, “Input” means the data output from EM3E drives to master station.

control word and status word

In PV Mode, bits 6-4 of control word (6040h) are invalid, so it need only to set motion parameters: target velocity (60FFh), acceleration/deceleration (6083h/6084h) for motion after the drive is enabled.

In PV Mode, bits 15-12, 10, 8 of status word (6041h) are shown as the following table.

Table 5.26 Bits 15-12, 10, 8 of (6041h) in PV Mode

Bit (Name)	Value	Description
Bit 8(quick stop)	0	Quick stop is not triggered
	1	Quick stop is triggered
Bit 10(velocity reached)	0	Current velocity don't reach target velocity
	1	Target velocity reached
Bit 12 (velocity is value 0)	0	Velocity is not 0, motor is moving
	1	Velocity is value 0 or ready to reduce to value 0*1)

*1) In PV Mode, the bit will be valid if the deceleration stop is executed or hardware limit is activated.

5.6 Touch Probe Function Instructions

Touch probe function is used to record current position with sensing inputs from external signal in the operation mode of CSP or PP. There are two channels of digital input signal supporting the touch probe functions in EM3E series stepper drives.

5.6.1 Trigger Signal Setting

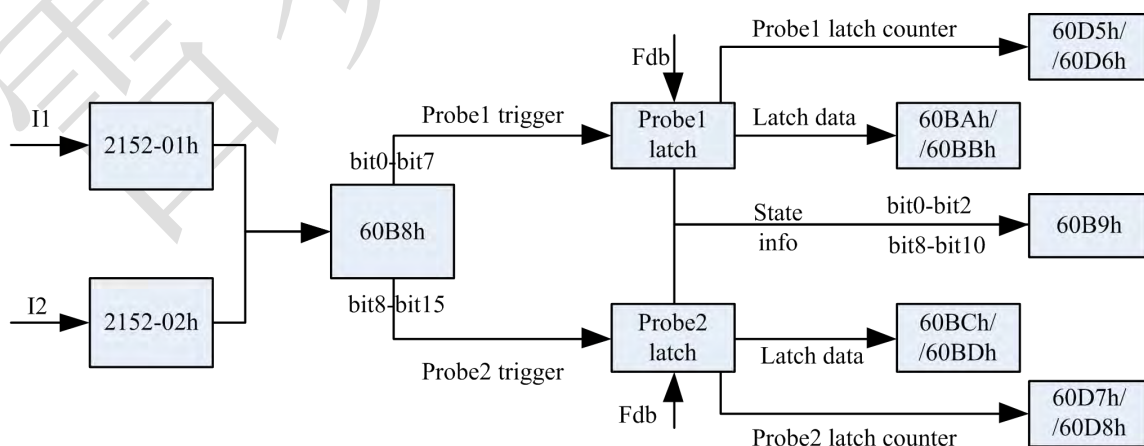

Figure 5.8 Touch probe function

When I1 or I2 is set to touch probe function, please refer to the notes as below:

a) When setting I1 or I2 as touch Probe1 (or touch Probe2), corresponding parameter 0x2152-01h or 0x2152-02h

is set to value '32' (or '64');

- b) Control word (60B8h) (low 8 bits mapping touch probe1, high 8 bits mapping touch probe2) settings include switch on, time mode, trigger edge, and so on. Please special attention to:
- (i) When using I1 or I2 signal to trigger touch probe, the logic setting of I1 or I2 must be the same as the 60B8h (touch probe), otherwise, the touch probe function is invalid.
 - (ii) In single time mode, the active edge can not be set to both rising edge and falling edge, but feasible for continuous time mode.
 - (iii) When I1 and I2 are set to the same touch probe, if I1 and I2 have pulse inputs with same timing sequence, the touch probe will respond one of them; and if not, the touch probe will respond the overlay events triggered by I1 and I2.

5.6.2 Related Object

Table 5.27 Related object list of touch probe

Index	Sub-index	Name	Access type	Data type	Unit	Range	Default value
2152h	01h	I1 function setting	RW	Uint16	—	0-32768	1
	02h	I2 function setting	RW	Uint16	—	0-32768	2
60B8h	00h	Touch probe function	RW	Uint16	—	0-65535	0
60B9h	00h	Touch probe state	RO	Uint16	—	0-65535	0
60BAh	00h	Rising edge of touch probe1 to latch position	RO	int32	Instruction unit	-2147483648~2147483647	0
60BBh	00h	Falling edge of touch probe1 to latch position	RO	int32	Instruction unit	-2147483648~2147483647	0
60BCh	00h	Rising edge of touch probe2 to latch position	RO	int32	Instruction unit	-2147483648~2147483647	0
60BDh	00h	Falling edge of touch probe2 to latch position	RO	int32	Instruction unit	-2147483648~2147483647	0
60D5h	00h	Rising edge of touch probe1 to trigger counter	RO	Uint16	—	0-32768	0
60D6h	00h	Falling edge of touch probe1 to trigger counter	RO	Uint16	—	0-32768	0
60D7h	00h	Rising edge of touch probe2 to trigger counter	RO	Uint16	—	0-32768	0
60D8h	00h	Falling edge of touch probe2 to trigger counter	RO	Uint16	—	0-32768	0

5.6.3 I1 or I2 Pin Function Setting

Table 5.34 Pin function of touch probe input object (2152h-01h/02h)

Value	1	2	4	8	16	32	64
Function	Home signal	Negative limit switch	Positive limit switch	Quick stop	User defined	Probe1	Probe2

5.6.4 The Object of Touch Probe Function Control

Table 5.35 Touch probe control object (60B8h)

Bit	Value	Description	
0	0	Touch probe1 disabled	Touch probe1 switch on / stop
	1	Touch probe1 enabled	
1	0	Single time mode	Time mode selection
	1	Continuous time mode	
2	-	Reserved	Reserved
3	-	Reserved	Reserved
4	0	Rising edge disabled	Rising edge selection
	1	Rising edge enabled	
5	0	Falling edge disabled	Falling edge selection
	1	Falling edge enable	
6	-	Reserved	Reserved
7	-	Reserved	Reserved
8	0	Touch probe2 disabled	Touch probe1 switch on / stop
	1	Touch probe2 enabled	
9	0	Single time mode	Time mode selection
	1	Continuous time mode	
10	-	Reserved	Reserved
11	-	Reserved	Reserved
12	0	Rising edge disabled	Rising edge selection
	1	Rising edge enabled	
13	0	Falling edge disabled	Falling edge selection
	1	Falling edge enable	
14	-	Reserved	Reserved

15	-	Reserved	Reserved
----	---	----------	----------

5.6.5 The Object of Touch Probe State

Table 5.36 Touch probe state object (60B9h)

Bit	Value	Description
0	0	Touch probe1 no action
	1	Touch probe1 in action
1	0	Rising edge of probe1 uncompleted
	1	Rising edge of probe1 completed
2	0	Falling edge of probe1 uncompleted
	1	Falling edge of probe1 completed
3-5	-	Reserved
6-7	-	Reserved
8	0	Touch probe2 no action
	1	Touch probe2 in action
9	0	Rising edge of probe2 uncompleted
	1	Rising edge of probe2 completed
10	0	Falling edge of probe2 uncompleted
	1	Falling edge of probe2 completed
11-13	-	Reserved
14-15	-	Reserved

5.6.6 Latch Data Registers

Table 5.37 Touch probe latch object (60BAh/60BBh/60BCh/60BDh)

Object dictionary	Description
60BAh	Indicates the latch position point of touch probe1 rising edge
60BBh	Indicates the latch position point of touch probe1 falling edge
60BCh	Indicates the latch position point of touch probe2 rising edge
60BDh	Indicates the latch position point of touch probe2 falling edge

5.6.7 Latch Counter Registers

Table 5.38 Touch probe latch register object (60D5h/60D6h/60D7h/60D8h)

Object dictionary	Description
60D5h	Indicates in continuous mode, the rising edge of touch probe1 to latch counter
60D6h	Indicates in continuous mode, the falling edge of touch probe1 to latch counter
60D7h	Indicates in continuous mode, the rising edge of touch probe2 to latch counter
60D8h	Indicates in continuous mode, the falling edge of touch probe2 to latch counter

5.6.8 Touch probe Action Switches On

During the time of bit0 / bit8 of object (60B8h) changing from value "0 (stop) → 1 (switch on) ", obtain setting conditions of other bits(60B8h: bit1-7 / bit9-15), then switch on touch probe.

After enable the changing of all setting conditions, the bit0 / bit8 of 60B8h need return to "0 (stop) ", then change to "1 (switch on) " once again.

5.6.9 Time Mode of Touch Probe

Time mode selection object (60B8h) can be set to "0 (single time mode) "and "1 (continuous time mode)".

(1) Single time mode:

After switching on, it will execute latch position in the first trigger, you need to start touch probe action (the bit0 / bit8 of 60B8h need return to "0", then change to "1") once again for saving another latch position value, the timing sequence is shown as below:

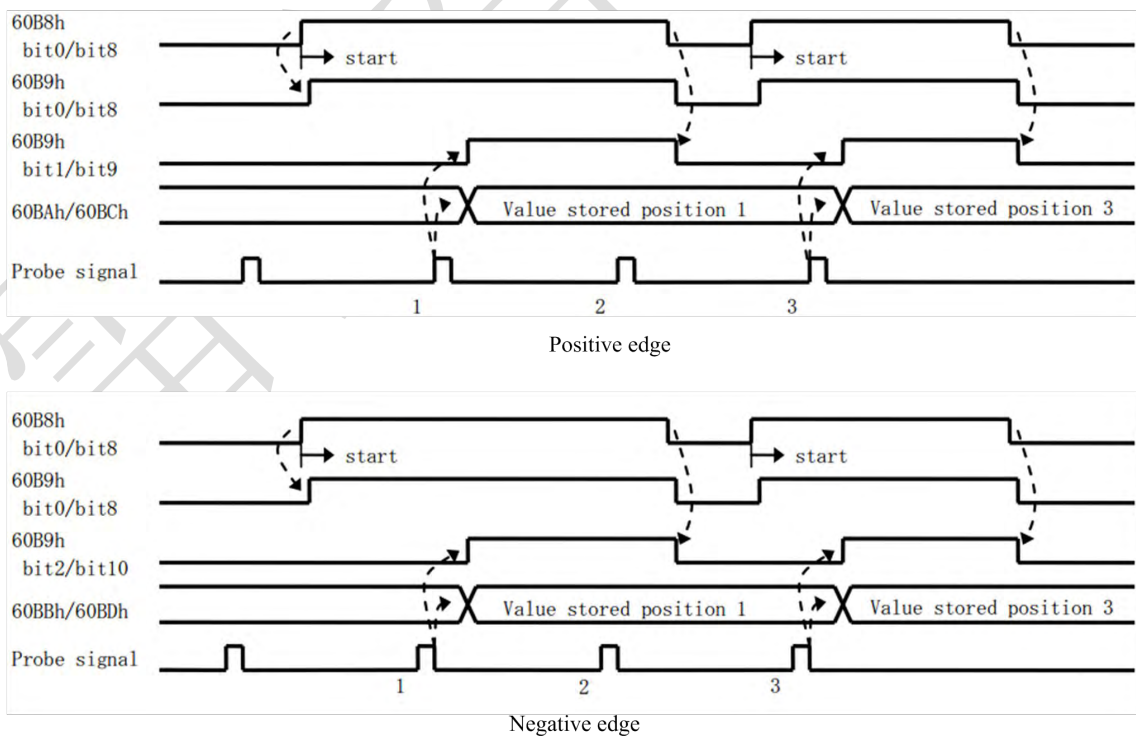
Figure 5.9 Single time mode

(2) Continuous time mode:

After switching on this continuous mode, each latch position value triggered by the probe signal can be stored till the last probe signal trigger, the timing sequence is shown as below:

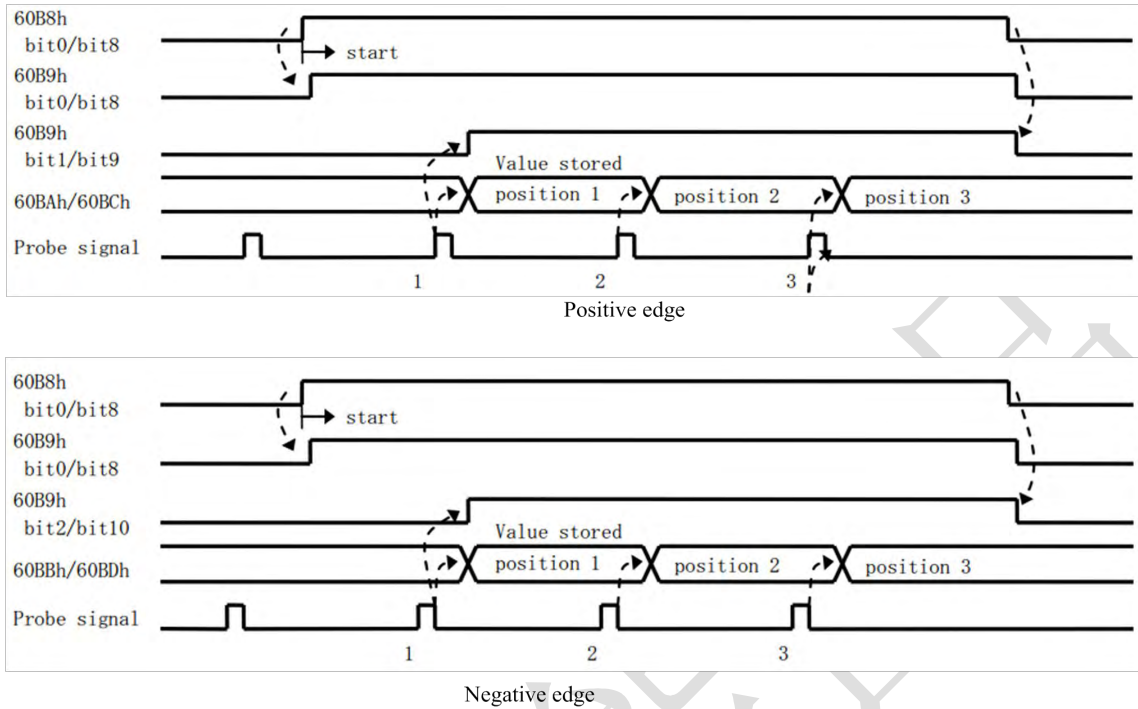

Figure 5.10 continuous time mode

5.6.10 Other status indication of touch probe

You can observe the object (60FDh) to judge whether touch probe triggering action is completed.

Table 5.37 Touch probe state indication

60FDH	Bit 26	Bit 27
	Trigger flag of touch probe1	Trigger flag of touch probe2

6 Drive Operating Instructions

6.1 Function Operating

6.1.1 Save parameters

EM3E series stepper drives provide a method of saving parameter through setting the address 1010h+04. If the address 1010h+04 is set to value 0x65766173, the drive will save all of the present parameters to EEPROM.

Note: (1) Don't turn off the power when saving parameters to EEPROM; otherwise it will save wrong parameters to EEPROM. If it happens, you need to configure all of the parameters again, then write 0x65766173 to the address 1010h+04.

6.1.2 Factory reset

EM3E series stepper drives provide a method of factory resetting through setting address 1011h+04, if the address 1011h+04 is set to value 0x64616f6c, the drive will restore the factory setting.

6.2 Before Using

Table 6.1 Check items before operation

No	Item	Description
1	Accessories and wiring check	1. Accessories: Power connector, motor connector, control I/O signals connector. 2. Wirirng: EtherCAT communication port need correct and stable wiring, power and motor wiring should avoid short circuit.
2	Power voltage check	1. The polarity of power supply must be correct. 2. The power supply must be within the range of operation voltage.
3	Fixed installation check	1. The motor and drive must be fixed to install.
4	Unload check	1. The shaft of motor must be unloading in the package.
5	Control signals check	1. All of the switch must be at off state.

6.3 Field Bus Product Network

EM3E Series network diagram

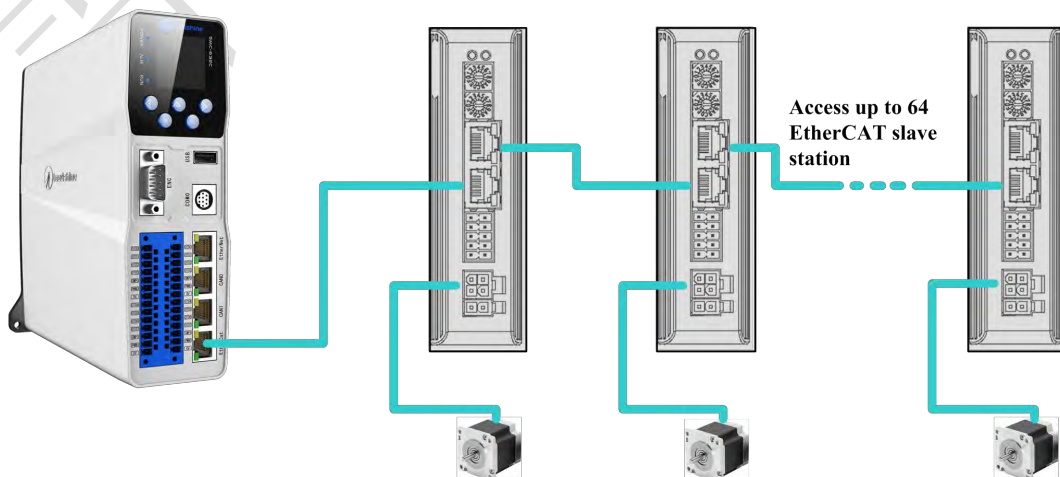

Figure 6.1 EM3E series network diagram

Note: SMC616 is the EtherCAT Controller designed by Leadshine.

6.3.1 Operation Mode

Relating to operation mode parameter setting:

Table 6.2 The corresponding object settings of each operation mode

Instruction type	Object	Operation mode
Field bus instruction	(6060h) = 1	Profile position mode (PP)
	(6060h) = 3	Profile Velocity mode (PV)
	(6060h) = 6	Homing mode (HM)
	(6060h) = 8	Syclic Synchronous Position mode (CSP)

6.3.2 The Necessary Configuration

Slave ID Address Setting

If you want to control the EM3E series drives by EtherCAT instructions, first you need to set the node ID address, the related objects are shown as below: (Please refer to [section 3.36](#))

Parameter Address	Name	Access	Default Parameter	Range	Description
2150+00	Slave Address	R/W/S	1	1-65535	Slave Address
2151+00	How to set Slave Address	R/W/S	0	0-2	0: Rotary Switches 1: Object 2150h 2: ESC EEPROM

EtherCAT Slave Information

EtherCAT Slave Information file (XML File or ESI file) is needed to connect controller with EtherCAT Master.

This file is provided by Leadshine, described slave device information as XML format based on EtherCAT specifications. Please follow the EtherCAT Master software manual for importing method.

Some master stations require files in a specific format and do not recognize XML format, please contact the master technical engineer of master station..

7 Alarm and Processing



L1: Power/Alarm Indicator
L2: EtherCAT Communication Indicator

Figure 7.1 LED Indicator

7.1 Error Codes

7.1.1 EM3E Series Drives Errors

If a fault has occurred in the EM3E Series EtherCAT drives, the red LED of L1 (Fig 7.1) will flash and the stepper motor will stop working. The alarm codes and the red LED of L1 status are shown as below:

Table 7.1: Error code of drives and flash times of L1 red LED

3FFeH ^①	1001h ^②	603Fh ^③	Alarm Description	Flash Times	Alarm Can Be Cleared ^④
0x0e0	0x02	0x2211	Over current	1	No
0x0a0	0x04	0x3150	A phase amplifier failure	12	No
0x0a1	0x04	0x3151	B phase amplifier failure	12	No
0x0c0	0x04	0x3211	Over voltage	2	Yes
0x1a0	0x20	0x8402	Over velocity error	5	Yes
0x240	0x80	0x5530	EEPROM error	8	Yes
0x1a1	0x20	0x8403	Command exceed limit	3	Yes
0x5f0	0x80	0x7122	Motor cable error	7	No
-	-	-	Hardware burnout	Always on	-

- ① The alarm codes mean history alarm show in the object 3FFeH.
- ② The alarm codes mean current alarm from CIA profile, shown in the object 1001h.
- ③ The alarm codes mean current alarm from IEC 61800 profile, shown in the object 603Fh.
- ④ It means after resolving the problem that caused the error, if it's necessary to restart power to clear alarm of the drives. 'No' means it has to restart power; 'Yes' means no need, and the two processing methods are as below:

A. Set the value 1 to object 2057h to clear alarm.

B. In order to change the 402 state machines from ‘Fault’ to ‘Switch on disabled’, set the value of object 6040h+07h range from 0 to 1.

C. Set the value 1 to object 2093h to clear history alarm

Note :

(1) Error codes of some master controller are displayed in decimal, you need to convert to hexadecimal, and then refer to this table

(2) Due to some master station system problems, when the driver fails, the red Alarm indicator will only flash once, mistakenly thinking it is an over-current alarm. Therefore, it is strongly recommended that in the event of a failure, it is best to see the error code displayed in the object dictionary.

(3) When multiple alarms occur, all the related objects will update to the newest state.

7.1.2 EtherCAT Communication Errors

If a fault has occurred in the EtherCAT communication, the alarm codes and the red LED of L2 (Fig 7.1) status are shown as below:

Table 7.2 Alarm codes of drives and flash state of L2 red LED

603Fh	1001h	Alarm Description	3FFEh	Alarm Can Be Cleared [®]	Save or not	ERR LED [®]
0x8213	0x10	BOOT is not supported	-	Yes	No	Flickering Flash
0x8215	0x10	Invalid configuration in BOOT mode	Blanks are not saved	Yes	No	Flickering Flash
0x8216	0x10	Invalid configuration of pre-operation	-	Yes	No	Flickering Flash
0x8217	0x10	Invalid configuration of SM	-	Yes	No	Flickering Flash
0x821B	0x10	Watchdog time-out of SM	0x001B	Yes	Yes	Double Flash
0x821C	0x10	Invalid type of SM	0x001C	Yes	Yes	Blinking Flash
0x821D	0x10	Invalid configuration of output	-	Yes	No	Blinking Flash
0x821E	0x10	Invalid configuration of input	-	Yes	No	Blinking Flash
0x821F	0x10	Invalid configuration of watchdog	-	Yes	No	Blinking Flash
0x8224	0x10	Invalid TPDO mapping	-	Yes	No	Blinking Flash
0x8225	0x10	Invalid RPDO mapping	-	Yes	No	Blinking Flash
0x871A	0x10	Synchronous mode error	0x001A	Yes	Yes	Single Flash
0x8727	0x10	Free-run mode is not supported	-	Yes	No	Blinking Flash
0x8728	0x10	Synchronous mode is not supported	-	Yes	No	Blinking Flash
0x872C	0x10	Fatal synchronous error	-	Yes	Yes	Blinking Flash

0x872D	0x10	No synchronous error	-	Yes	No	Single Flash
0x872E	0x10	Too small synchronous cycle	-	Yes	No	Blinking Flash
0x8730	0x10	Invalid configuration of DC	-	Yes	No	Blinking Flash
0x8732	0x10	DC PLL error	0x0032	Yes	Yes	Single Flash
0x8733	0x10	DC synchronous IO error	0x0033	Yes	Yes	Single Flash
0x8734	0x10	DC synchronous overtime	0x0034	Yes	Yes	Single Flash
0x8735	0x10	Invalid DC cycle	-	Yes	No	Blinking Flash
0x8736	0x10	Invalid sync0 cycle	-	Yes	No	Blinking Flash
0xA001	0x10	Invalid ESM state transition	0x0011	Yes	Yes	Blinking Flash
0xA002	0x10	Unknown ESM transition request	0x0012	Yes	Yes	Blinking Flash
0xA003	0x10	A request of slave wait for initialization	0x0021	Yes	Yes	Blinking Flash
0xA004	0x10	A request of slave wait for pre-operation	0x0022	Yes	Yes	Blinking Flash
0xA005	0x10	A request of slave wait for secure operation	0x0023	Yes	Yes	Blinking Flash

⑤ Please refer to the [section 7.1](#).for ERROR LED display meanings.

⑥ All of the communication errors can be cleared without restoring power.The master station processing steps are as below:

- A. Master station write value 1 to the bit4 (error state) of EM3E stepper drive ESC control register (0x120).
- B. After handling errors, the value of EM3E stepper drive ESC state register (0x134-0x135) will be set to value 0, and then the communication alarms will be released.
- C. In order to change the 402 state machines from 'Fault' to 'Switch on disabled', set the value of object 6040h+07h range from 0 to 1.

Note: When multiple alarms occur, all the related objects will update to the newest state.

8. Warranty

Twelve Month Warranty

Leadshine Technology Co., Ltd. warrants its products against defects in materials and workmanship for a period of 12 months from shipment out of factory. During the warranty period, Leadshine will either, at its option, repair or replace products which proved to be defective.

Exclusions

The above warranty does not extend to any product damaged by reasons of improper or inadequate handlings by customer, improper or inadequate customer wirings, unauthorized modification or misuse, or operation beyond the electrical specifications of the product and/or operation beyond environmental specifications for the product.

Obtaining Warranty Service

To obtain warranty service, please contact your seller to obtain a returned material authorization number (RMA) before returning product for service.

Shipping Failed Products

If your product fail during the warranty period, please contact your seller for how and where to ship the failed product for warranty or repair services first, you can also e-mail customer service at tech@leadshine.com to obtain a returned material authorization number (RMA) before returning product for service. Please include a written description of the problem along with contact name and address.

Appendix A. Object Dictionary

Object Address	Communication Parameters	Access Type	Default Value	Range	Description	
1000+00	Device Type	R	0x00040192	-	Bit 0~15: Device profile number Bit 16~31: Additional information	
1001+00	Error Register	R	0	-	0x02: over current 0x04: over voltage or amplifier error 0x20: command exceed limit or over velocity 0x80: EEPROM error or motor cable error	
1008+00	Device Name	R	EM3E-556	-	-	
1009+00	Hardware Version	R	V1.0	-	-	
100A+00	Software Version	R	V1.0	-	-	
1010	04	Save Parameters of User	R/W	0	-	Write 0x65766173 to save parameters Return to 1 after completion
	03	Save Parameters of Motion	R/W	0	-	Write 0x65766173 to save parameters Return to 1 after completion
	02	Save Parameters of Communication	R/W	0	-	Write 0x65766173 to save parameters Return to 1 after completion
	01	Save All Parameters	R/W	0	-	Write 0x65766173 to save parameters Return to 1 after completion
	00	Number of sub-index	RO	4	-	-
1011	04	Restore Parameters of User	R/W	0	-	Write 0x64616f6c to restore default value Return to 1 after completion
	03	Restore Default Parameters of Motion	R/W	0	-	Write 0x64616f6c to restore default value Return to 1 after completion
	02	Restore Default Parameters of Communication	R/W	0	-	Write 0x64616f6c to restore default value Return to 1 after completion
	01	Restore All Parameters	R/W	0	-	Write 0x64616f6c to restore default value Return to 1 after completion
	00	Number of sub-index	RO	4	-	-
1018	00	Number of sub-index	RO	4	-	-
	01	Manufacture ID	RO	0x00004321	-	Leadshine Code
	02	Product Code	RO	0x00008100	-	-
	03	Revision Code	RO	0x00000001	-	-
	04	SN	RO	0x00000001	-	-
1600	01-08	RXPDO Mapping 1	R/W	-	Configurable object dictionary index + sub-index	
1601	01-08	RXPDO Mapping 2	R/W	-	Configurable object dictionary index + sub-index	
1602	01-08	RXPDO Mapping 3	R/W	-	Configurable object dictionary index + sub-index	
1603	01-08	RXPDO Mapping 4	R/W	-	Configurable object dictionary index + sub-index	
1A00	01-08	TXPDO Mapping 1	R/W/S	-	Configurable object dictionary index + sub-index	
1A01	01-08	TXPDO Mapping 2	R/W/S	-	Configurable object dictionary index + sub-index	
1C00	01	Mailbox Output Type	RO	1	-	-
	02	Mailbox Input Type	RO	2	-	-
	03	Process Output Data Types	RO	3	-	-
	04	Process Input Data Types	RO	4	-	-
1C12+00	RXPDO	R/W	0x1600	0x1600-0x1603	-	

		Assignment				
1C13+00		TXPDO Assignment	R/W	0x1A00	0x1A00-0x1A01 -	
Object Address		User Parameters	Access Type	Default Value	Range	Description
2000+00		Output Peak Current	R/W/S	1000	1000 to Maximum Current of Drives	Unit: mA, defined by user, but can't exceed the maximum output current of drives.
2001+00		Pulse per Revolution	R/W/S	50000	6400-51200	Required pulses for motor running one cycle
2002+00		Standby Time	R/W/S	500	100-10000	Unit: ms
2003+00		Standby Current Percentage	R/W/S	50	0-100	Unit: %
2005	01	Digital Output O1 Function Setting	R/W/S	1	1-16	1: alarm output 4: in-position output 8: brake output 16: master station control
	02	Digital Output O2 Function Setting	R/W/S	8	1-16	1: alarm output 4: in-position output 8: brake output 16: master station control
2007+00		Whether Lock Motor Shaft in Non-enable State	R/W/S	0	0/1	0: Unlock motor shaft 1: Lock motor shaft
2008+00		Digital Output Impedance Setting	R/W/S	0	0/1	0: positive logic 1: negative logic Bit 0 is mapping output1 Bit 1 is mapping output2
2009+00		Enable FIR Filter	R/WS	0	0/1	0: No 1: Yes
2010+01		Instructions FIR Time Setting	R/WS	1000	50-25600	Unit: us
2012+00		Soft-start Time	R/WS	4096	4000-65535	Unit: 50us
2013+00		Current Loop Auto-configuration	R/W/S	1	0/1	Current loop parameters auto-configuration when power on. 0: No 1: Yes
2015+00		Current Loop Kp	R/W/S	300	200-32767	If the object 2013h+00 is set 1, this object can be read only; If the object 2013h+00 is set 0, this object can be wrote, read and saved.
2016+00		Current Loop Ki	R/W/S	30	0-32767	If the object 2013h+00 is set 1, this object can be read only; If the object 2013h+00 is set 0, this object can be wrote, read and saved.
2017+00		Current Loop Kc	R/W/S	75	80-300	Keep Default
2020+00		Motor Resistance	R/W/S	1000	1-20000	Unit: mOhms
2021+00		Motor Inductance	R/W/S	1	1-6000	Unit: uH
2028+00		Output Setting Level	R/W/S	0	0-0xffff	Bit0 and Bit1 are used to control the polarities of output O1 and O2 respectively. 0 is means low level, 1 is means high level
2039+00		External Position H	R	0		High 16bit of received sum of position instructions

2040+00	External Position L	R/W	0		Low 16bit of received sum of position instructions Write: Write 1 to clear counter	
2043+00	Reference Velocity	R	0		Unit: r/min	
2048+00	Bus Voltage	R	0		Unit: V	
2051+00	Motor Rotation Direction	R/W/S	0	0/1	0: Motor rotation direction unchanged 1: Motor rotation direction reversed	
2056+00	Alarm detection selection	R/W/S	0xc3	0-0xffff	Select for whether detection the alarm by setting the bit value of this parameter : 1: Yes 0: No Bit0: Over current (The red LED of L1 flashed once), default setting 1; Bit1: Over voltage (The red LED of L1 flashed twice), default setting 1; Bit2: EEPROM (The red LED of L1 flashed 8 times), default setting 0; Bit3: Command exceed limit (The red LED of L1 flashed 5 times), default setting 0; Bit7: Motor cable error (The red LED of L1 flashed 7 times), default setting 0. Bit11: Amplifier error (The red LED of L1 flashed 12 times), default setting 0.	
2057+00	Clear Current Alarm	R/W	0	0/1	0: No 1: Yes	
2058+00	Enable Soft Start Function	R/W/S	0	0/1	0: No 1: Yes	
2073+00	Motor auto-running when power on	R/W/S	0	0/1	0: No 1: Yes, motor auto-turns 30° and reverse 30° when power on, then in standby state.	
2093+00	Clear History Alarm	R/W	0	0/1	0: No 1: Yes	
2150+00	Slave Address	R/W/S	1	1-65535	Slave station address: Activate after re-power	
2151+00	Slave Address Comes From	R/W/S	0	0-2	0: From rotation switch 1: From object 2150h 2: From ESC EEPROM	
2152	01	Digital Input I1 Function Setting	R/W/S	32	0-32768	1: Homing signal; 2: Positive limit; 4: Negative limit; 8: Emergency stop; 16: User defined; 32: Probe1 function; 64: Probe2 function
	02	Digital Input I2 Function Setting	R/W/S	1	0-32768	1: Homing signal; 2: Positive limit; 4: Negative limit; 8: Emergency stop; 16: User defined; 32: Probe1 function; 64: Probe2 function
	03	Digital Input I3 Function Setting	R/W/S	2	0-32768	1: Homing signal; 2: Positive limit; 4: Negative limit; 8: Emergency stop; 16: User defined; 32: Probe1 function; 64: Probe2 function
	04	Digital Input I4 Function Setting	R/W/S	4	0-32768	1: Homing signal; 2: Positive limit; 4: Negative limit; 8: Emergency stop; 16: User defined; 32: Probe1 function; 64: Probe2 function
	05	Digital Input I5 Function Setting	R/W/S	16	0-32768	1: Homing signal; 2: Positive limit; 4: Negative limit; 8: Emergency stop; 16: User defined; 32: Probe1 function; 64: Probe2 function
2153	01	Digital Input I1 Filter Time	R/W/S	1000	50-60000	Unit: us

	02	Digital Input I2 Filter Time	R/W/S	1000	50-60000	Unit: us
	03	Digital Input I3 Filter Time	R/W/S	1000	50-60000	Unit: us
	04	Digital Input I4 Filter Time	R/W/S	1000	50-60000	Unit: us
	05	Digital Input I5 Filter Time	R/W/S	1000	50-60000	Unit: us
2154+00		Digital Input Levels	R/W/S	0	0-65535	0: Unchanged 1: Reverse (bit0 is mapping digital input I1, and so on)
2155+00		The State of Digital Input	RO	0	0-32768	bit0 is mapping digital input I1, and so on
2163+00		In Place Function of Mode 1	R/W/S	0	10	0: Come from completing planning 10: Come from EtherCAT drives
3100	01	Software Version of EtherCAT Drives	RO	200	0-65535	-
	02	Software Version of FPGA	RO	0	0-65535	-
	03	Software Version of Field Bus	RO	208	0-65535	-
3FFE	01-0A	Alarm List	R/W/S	0	0-32767	3FFE+01 is the nearly alarm, others are history alarm
4003+00		Time delay for loosening brake	R/W/S	50	0-3000	Unit: ms Time from the enable state to the release of the brake
4004+00		Time delay for locking brake	R/W/S	50	0-3000	Unit: ms Time from non-enabled status to to shutdown PWM
5001+00		Internal Enable	RO	0	0-1	For internal tuning
5002+00		ESC Control Register	R/W	0	0-0xffff	For internal tuning
5003+00		ESC Date Register	RO	0	0-0xffff	For internal tuning
5004+00		DC Watchdog Counter	RO	0	0-0xffff	For internal tuning
5010+00		Watchdog Time	R/W	0	0-0xffff	For internal tuning
5013+00		The Code of Motor Don't Move	RO	0	0-0xffff	23: Don't support current mode 30: Command exceed velocity range
5014+00		Velocity Limit	R/W	1600	0-3000	Unit: r/min
Object Address	Motion Parameters	Access Type	Default Value	Range	Description	
603F+00	Nearly error code	RO	0	0-65535	The last time error code	
6040+00	Controlword	R/W	0	0-65535	Controlword	
6041+00	Stateword	RO	0	0-65535	Stateword	
605A+00	Emergency Stop Code	RW	5	0-65535	5: Slow down on slow down ramp and stay in Quick Stop Active Others: Invalid	
6060+00	Operating Mode	RW	8	0-255	Operating Mode: 1: Position Mode 3: Velocity Mode 6: Homing Mode 8: CSP Mode	

6061+00	Mode Check	RO	8	0-255	Display EtherCAT drives operating mode
6062+00	Command Position	RO	0	-2147483648 - 2147483648	Display motor command position
6064+00	Actual Position	RO	0	-2147483648 - 2147483648	Display motor actual position
606B+00	Command Velocity	RO	0	-2147483648 - 2147483648	Display motor command velocity
606C+00	Actual Velocity	R/W	0	-2147483648 - 2147483648	Display motor actual velocity
607A+00	Target Position	R/W	0	-2147483648 - 2147483648	Target position in position mode
607C+00	Home Offset	R/W	0	-2147483648 - 2147483648	Home offset
6081+00	Trapezoidal Velocity	R/W	50000	-2147483648 - 2147483648	Maximum velocity in position mode
6082+00	Start and Stop Velocity	R/W	0	-2147483648 - 2147483648	Start and stop velocity in mode 1
6083+00	Trapezoidal Acceleration	R/W	50000	-2147483648 - 2147483648	Acceleration with trapezoidal curve in PV or PP mode
6084+00	Trapezoidal Deceleration	R/W	50000	-2147483648 - 2147483648	Deceleration with trapezoidal curve in PV or PP mode
6085+00	Emergency Stop Deceleration	R/W	5000000	-2147483648 - 2147483648	Deceleration of emergency stop, this effect depends on the object 605Ah
6098+00	Homing Mode	R/W	19	0-100	Search for home signal
6099	01 Velocity in Homing Mode	R/W	50000	-2147483648 - 2147483648	The velocity of searching for limit switch
	02 Velocity in Homing Mode	R/W	25000	-2147483648 - 2147483648	The velocity of home signal
609A+00	Homing Acceleration/Deceleration	R/W	25000	-2147483648 - 2147483648	Acceleration/deceleration of homing mode
60B8+00	Probe Control word	R/W	0	0-65535	Setting the function of probe (refer to the detail description of probe function)
60B9+00	Probe State word	RO	0	0-65535	Display the state of probe function (refer to the detail description of probe function)
60BA+00	Probe 1 Rising Edge Latched Position	RO	0	-2147483648 - 2147483648	Probe 1 rising edge latched position data
60BB+00	Probe 1 Falling Edge Latched Position	RO	0	-2147483648 - 2147483648	Probe 1 falling edge latched position data
60BC+00	Probe 2 Rising Edge Latched Position	RO	0	-2147483648 - 2147483648	Probe 2 rising edge latched position data
60BD+00	Probe 2 Falling Edge Latched position	RO	0	-2147483648 - 2147483648	Probe 2 falling edge latched position data
60C2	01 RO	RO	2	0-255	Setting interpolation time cycle, just for tuning
	02 RO	RO	0	-128 - 127	Setting interpolation time index number, just for tuning
60D5+00	Probe 1 Rising Edge Trigger Counter	RO	0	0-65535	Record the trigger times probe 1 rising edge
60D6+00	Probe 1 Falling Edge Trigger Counter	RO	0	0-65535	Record the trigger times probe 1 falling edge
60D7+00	Probe 2 Rising Edge Trigger Counter	RO	0	0-65535	Record the trigger times probe 2 rising edge
60D8+00	Probe 2 Falling Edge Trigger Counter	RO	0	0-65535	Record the trigger times probe 2 falling edge
60FD+00	Digital Input State	RO	0	0-4294967296	bit0: Negative limit bit1: Positive limit

						bit2: Homing signal bit16: Emergency stop bit17-bit21: Input level of IN1-IN5 with user defined bit26: Probe 1 command of competing trigger [®] bit27: Probe 2 command of competing trigger [®]
60FE	01	Open the Physical Output	R/W	0	0-4294967296	When 2005h+01/02 is set to main station control, master controller can use the combination of 60FE+01 and 60FE+02 to control IO output:
	02	Enable the Physical Output	R/W	0	0-4294967296	When bit16 of 60FE+01 and 60FE+02 are both '1', O1 has output When bit17 of 60FE+01 and 60FE+02 are both '1', O2 has output, and so on.
60FF+00	Target Velocity	R/W	0	-2147483648 - 2147483648	Maximum velocity in velocity mode	
6502+00	Supported Operating Mode	RO	165	0-4294967296	Supported operating mode	

Appendix B. Homing Methods

As EM3E series EtherCAT stepper drives are open loop drives, supported 17-34, 35/37 homing modes currently. Specific motion trail of various homing methods are shown as below:

No. 17:

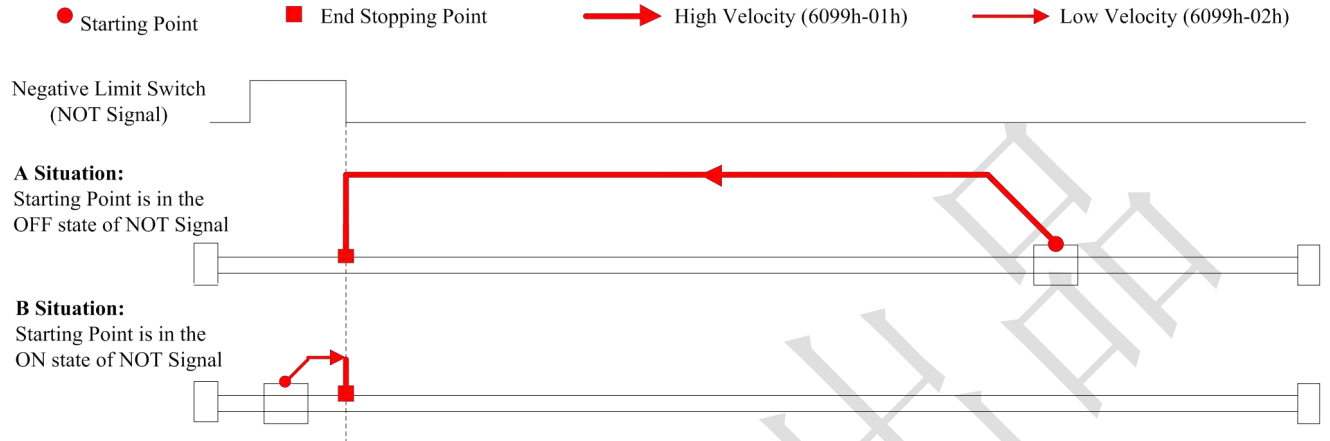

Figure 8.1 No.17 homing method

No. 18:

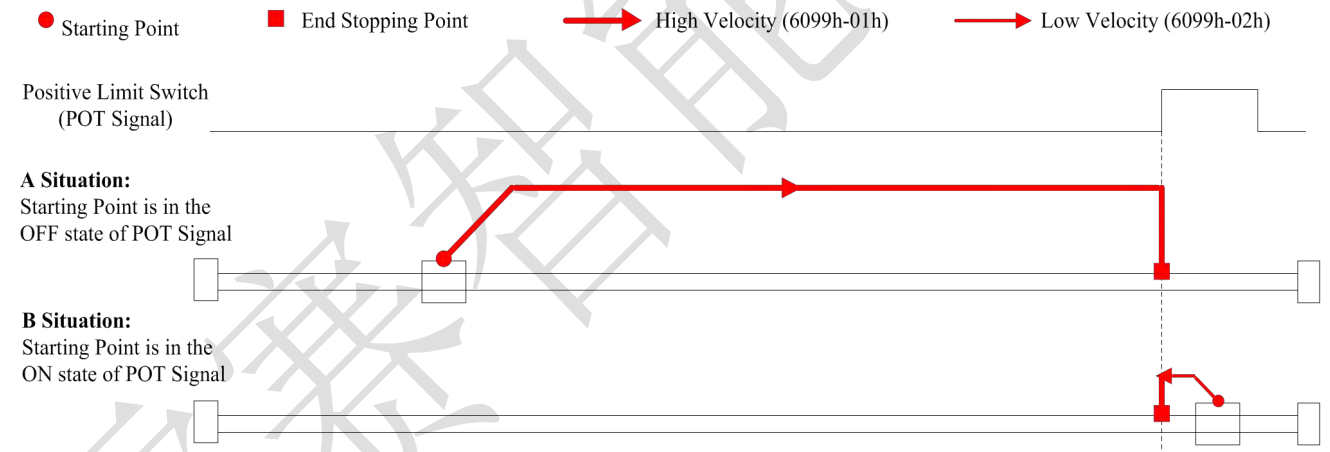

Figure 8.2 No.18 homing method

No. 19:

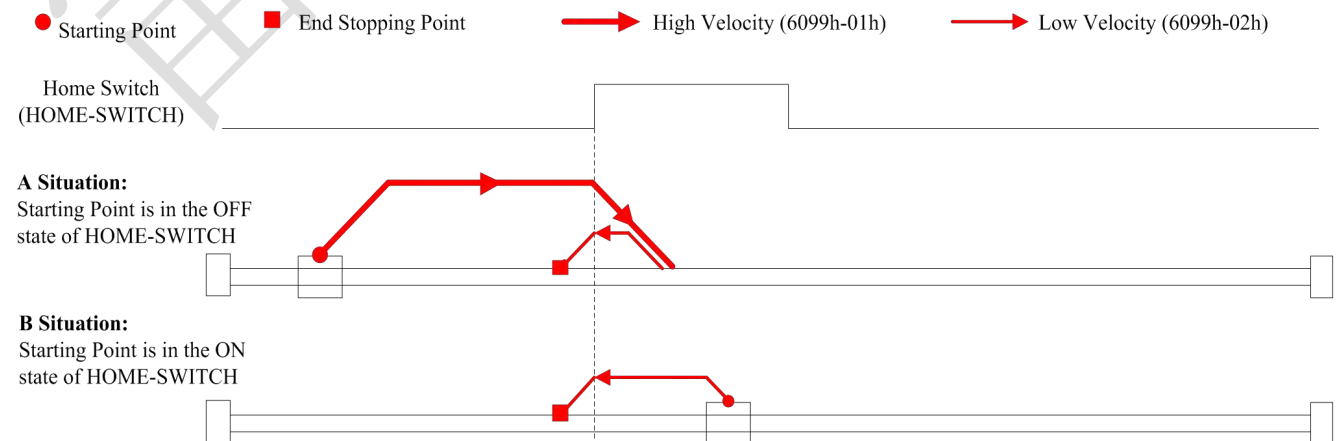
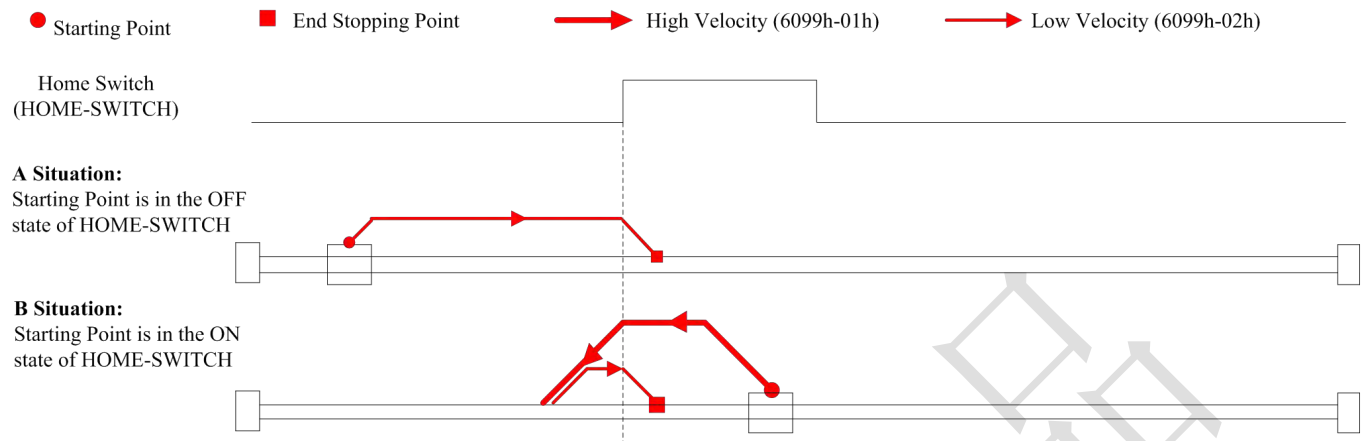
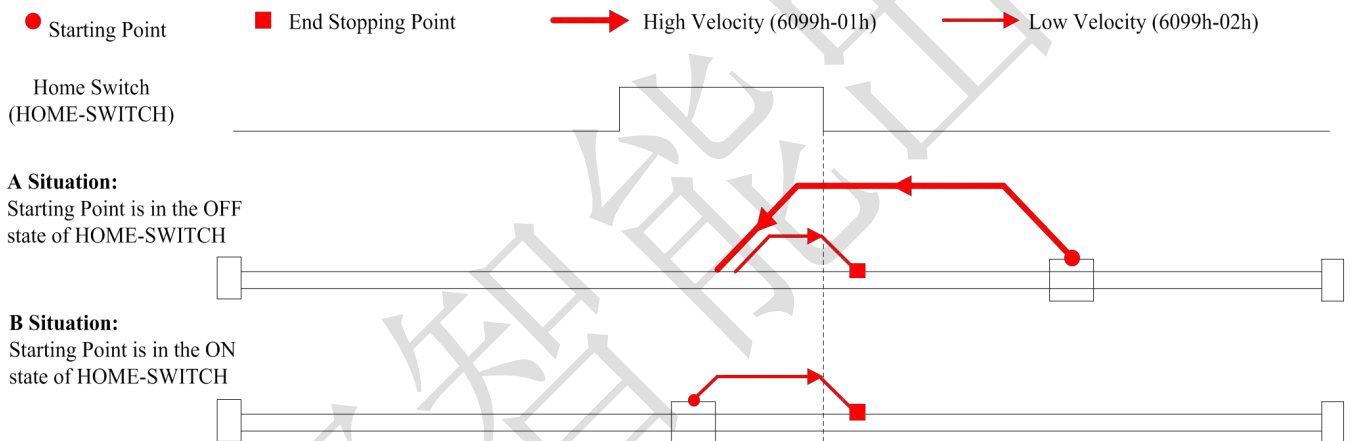
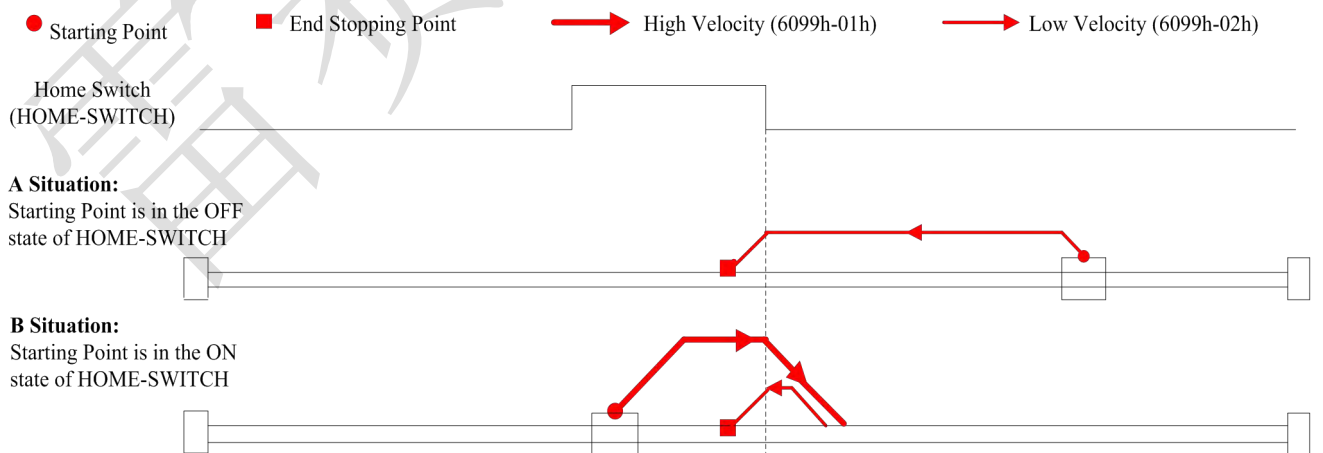
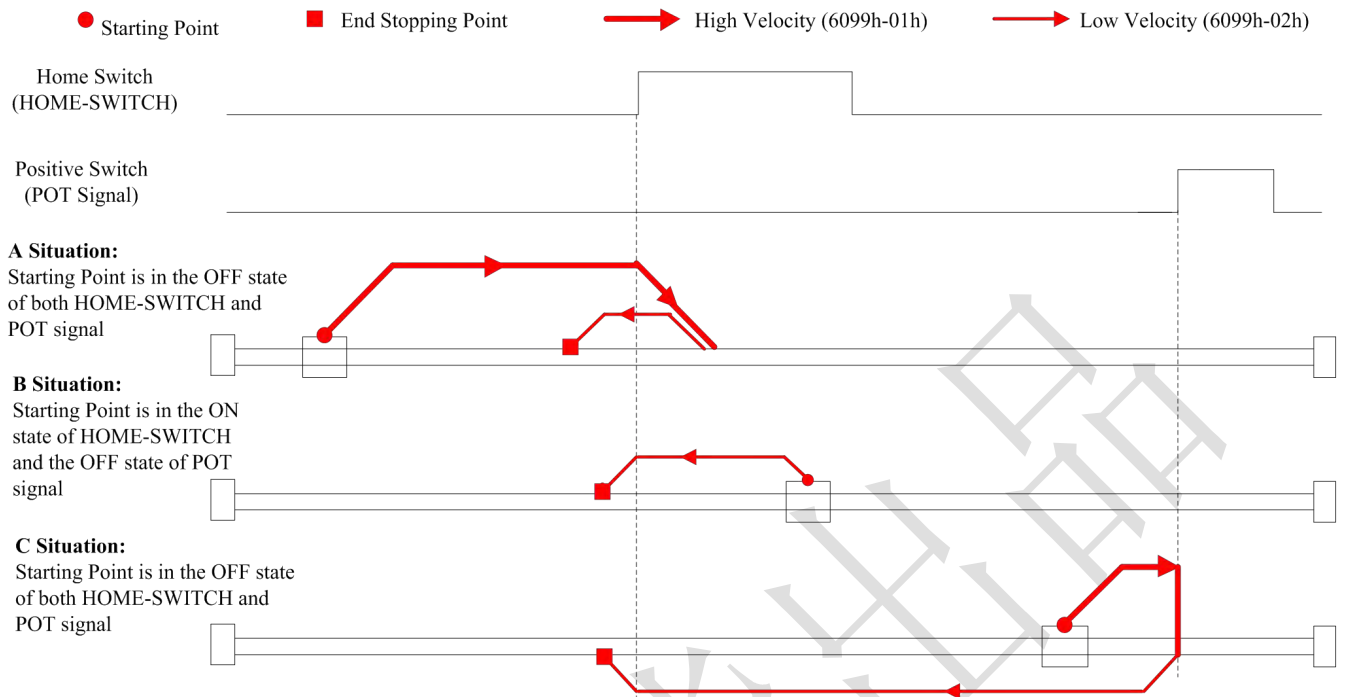
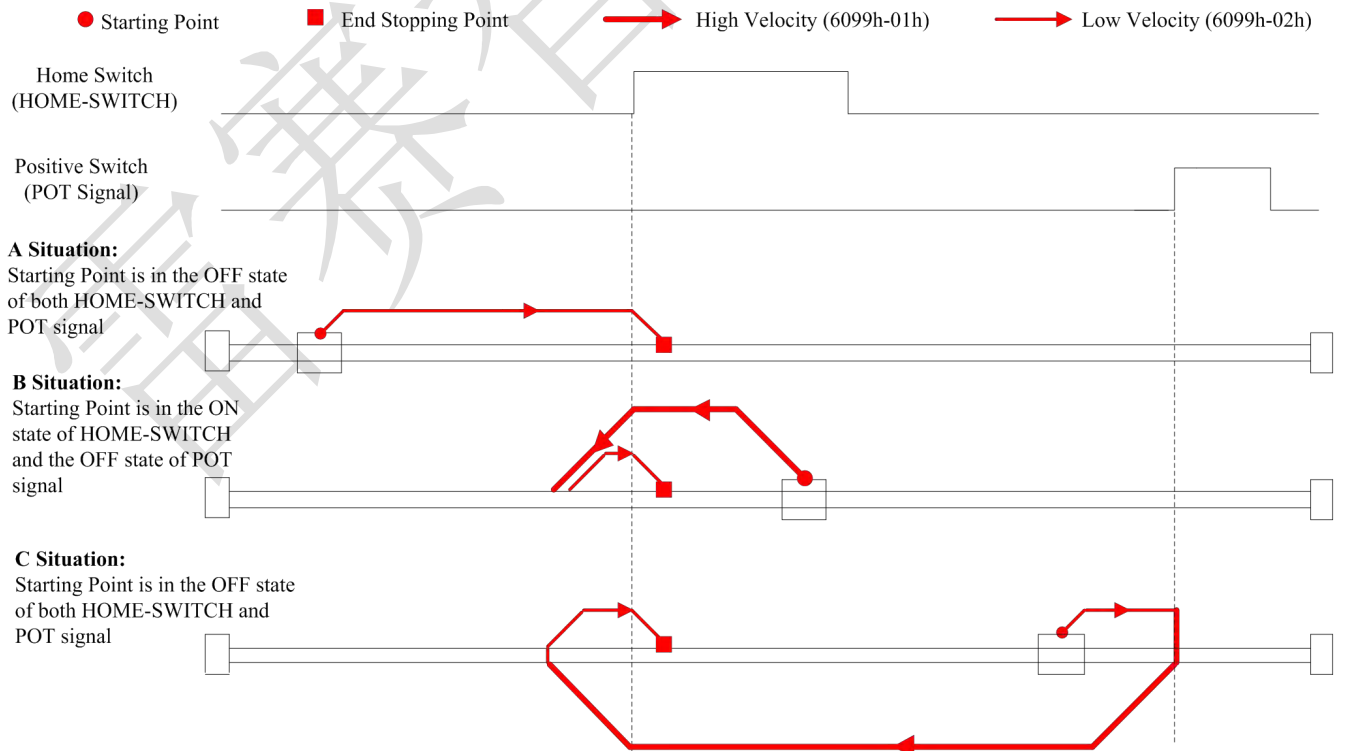
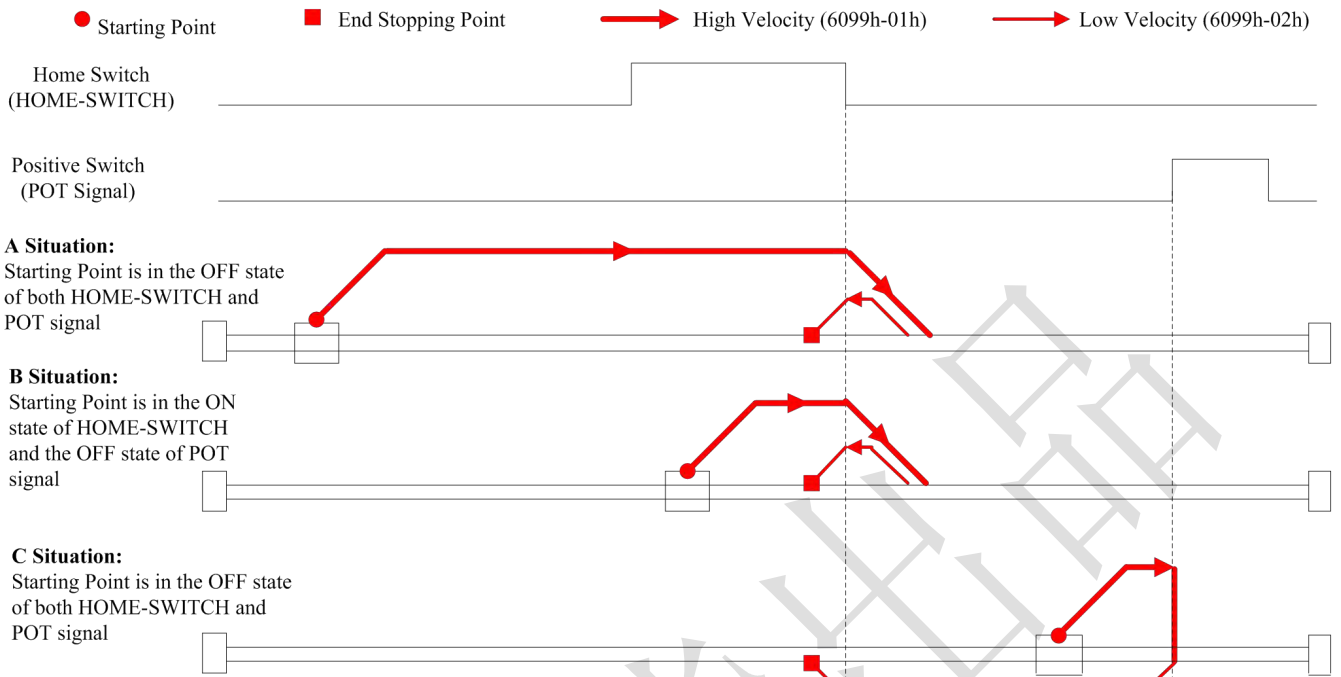
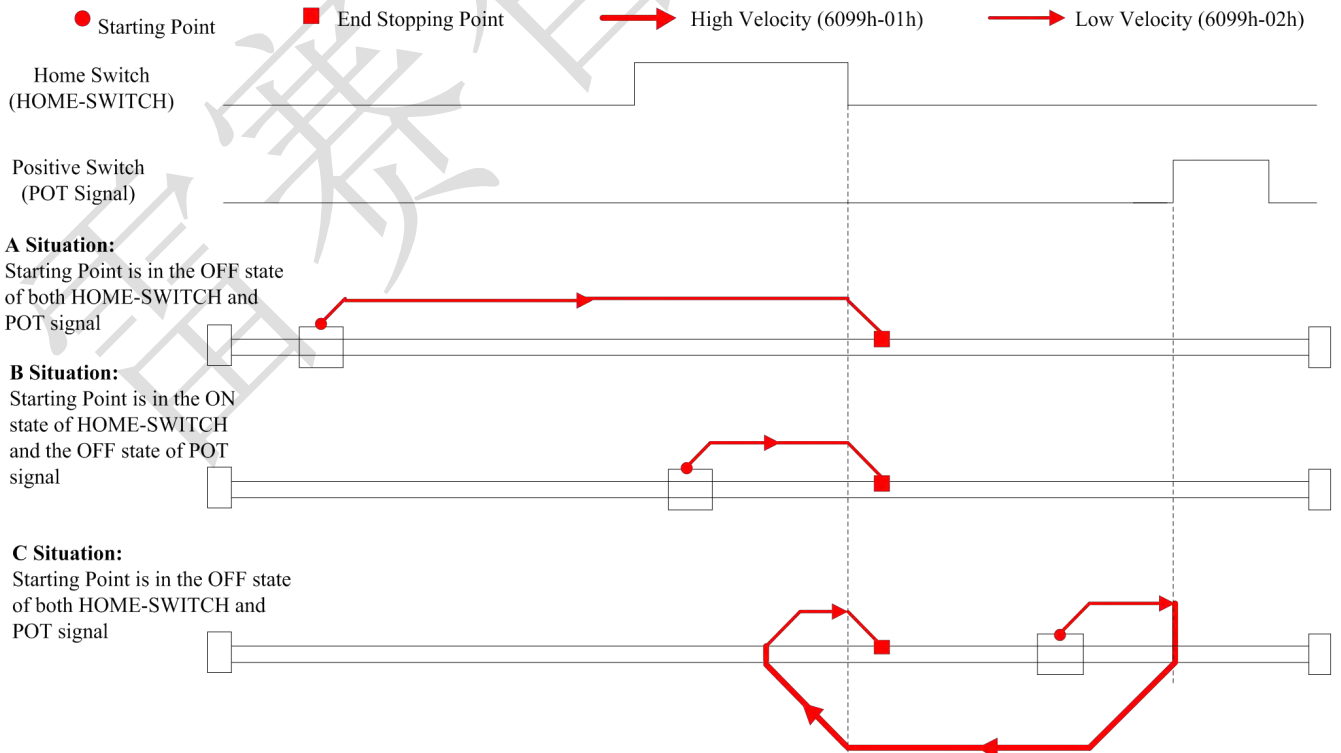
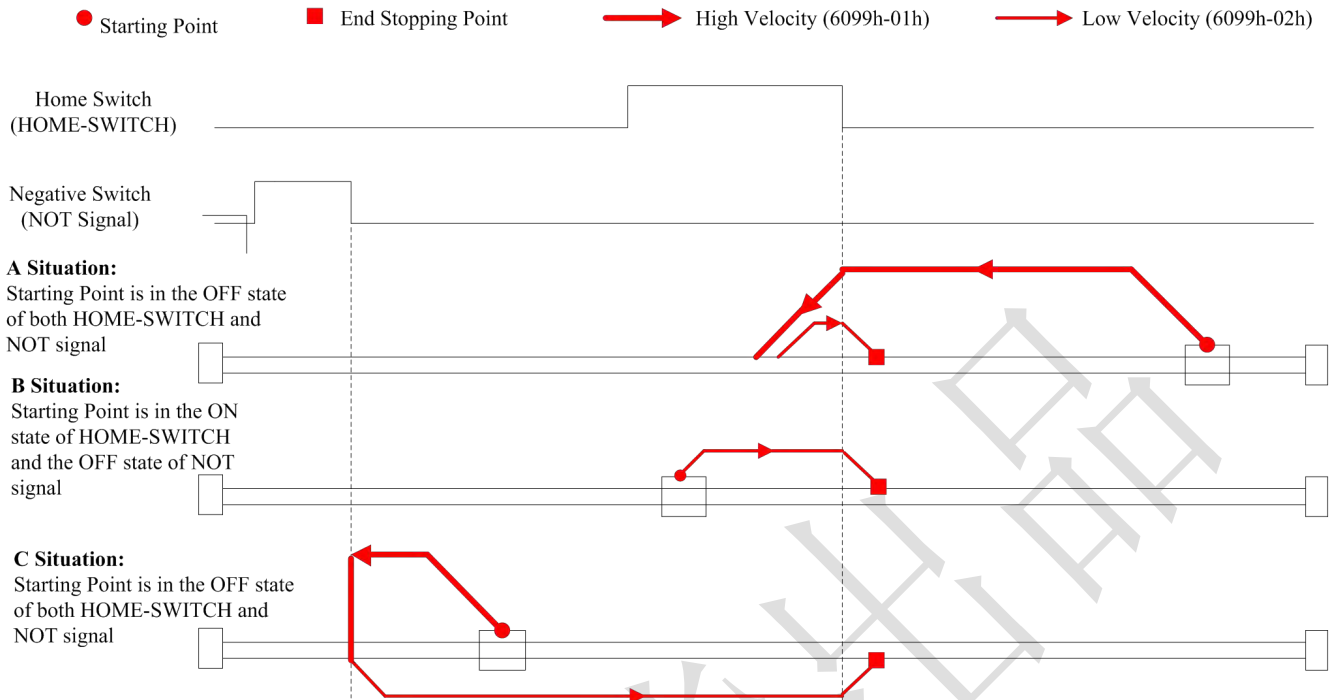
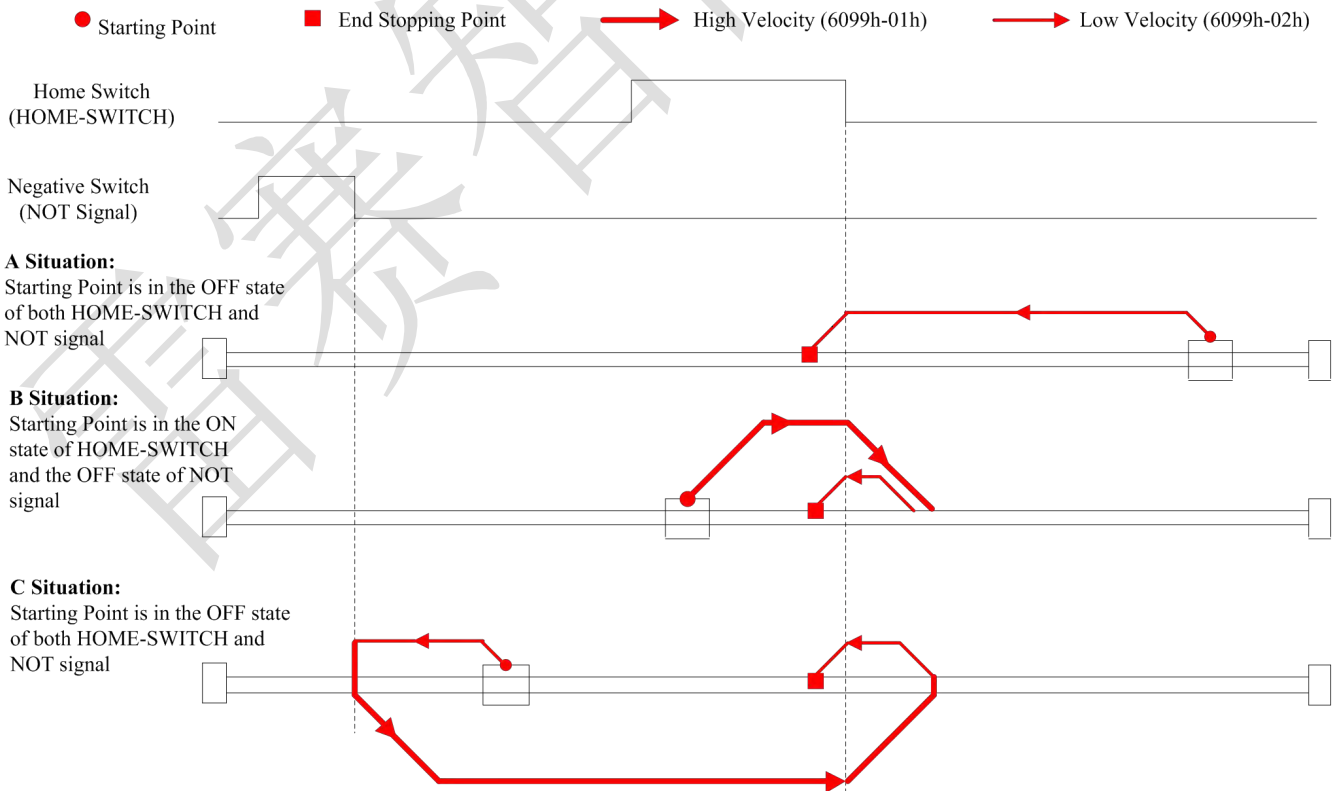

Figure 8.3 No.19 homing method

No. 20:

Figure 8.4 No.20 homing method
No. 21:

Figure 8.5 No.21 homing method
No. 22:

Figure 8.6 No.22 homing method

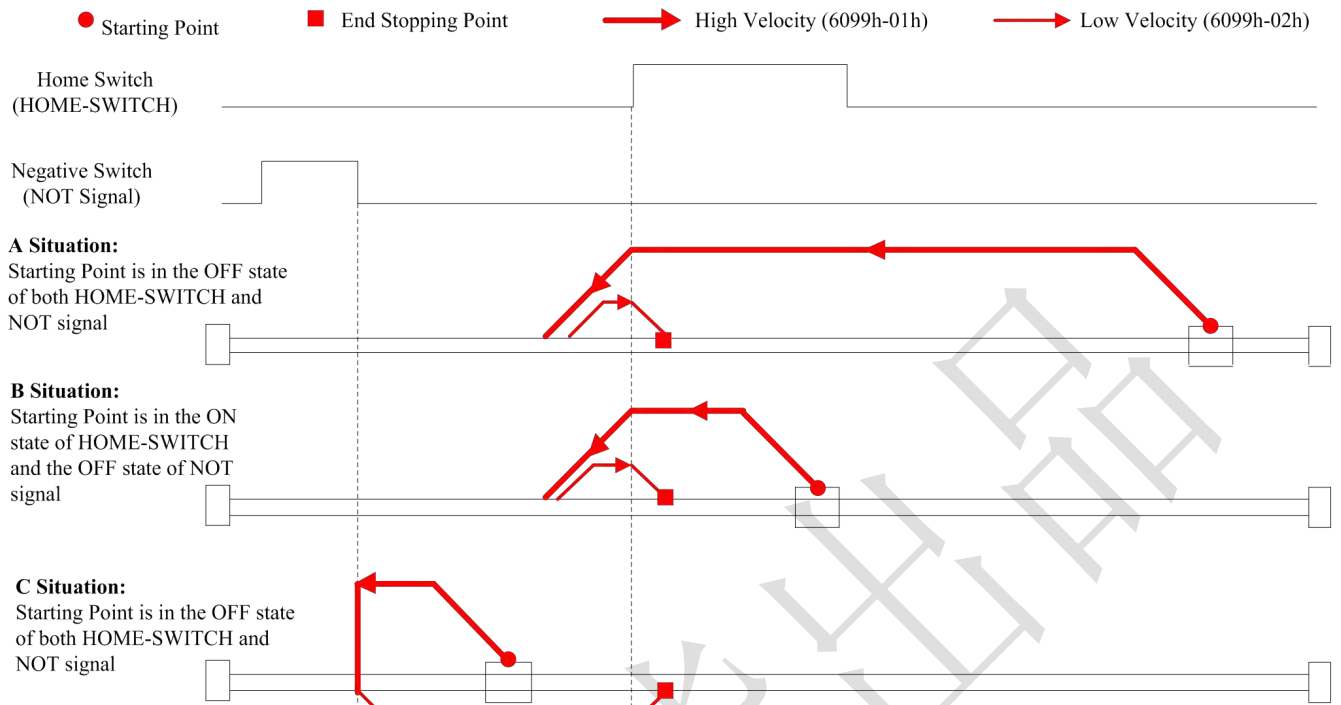
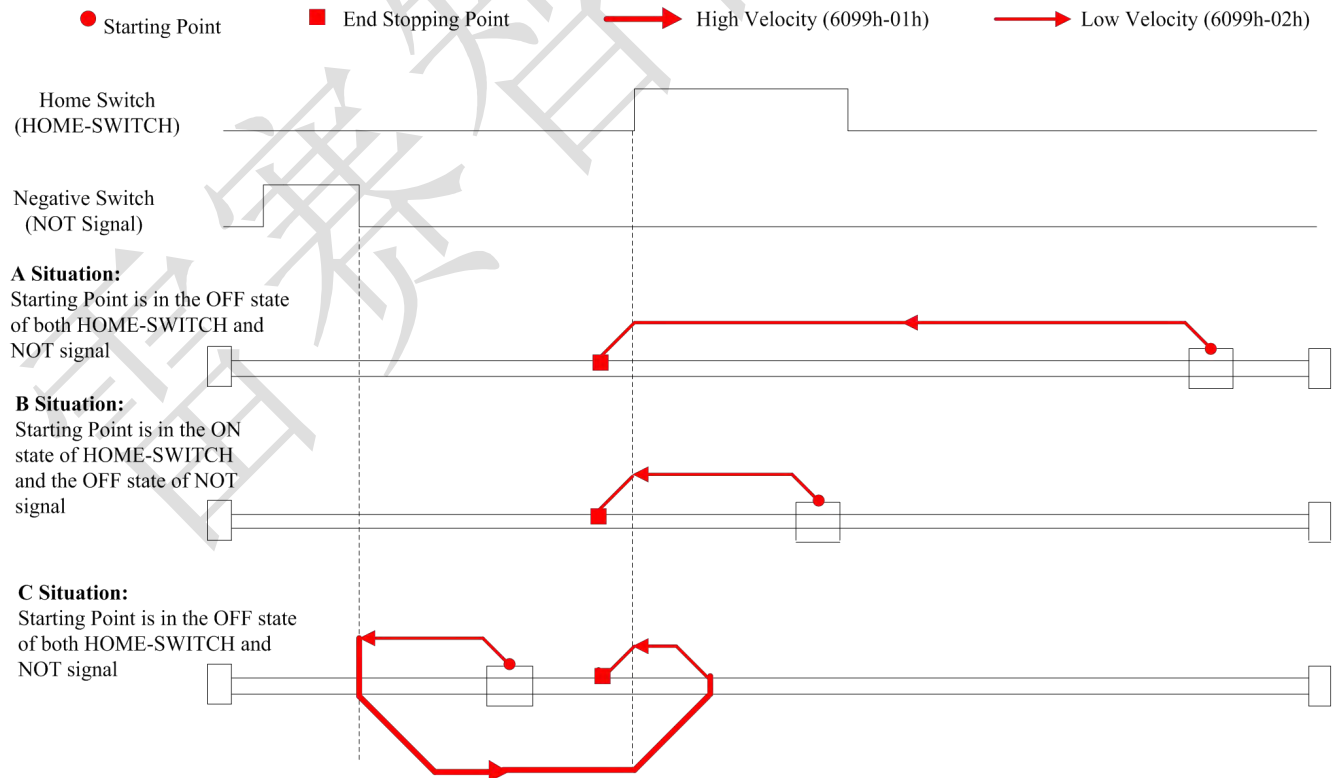
No. 23:

Figure 8.7 No.23 homing method
No. 24:

Figure 8.8 No.24 homing method

No. 25:

Figure 8.9 No.25 homing method
No. 26:

Figure 8.10 No.26 homing method

No. 27:

Figure 8.11 No.27 homing method
No. 28:

Figure 8.12 No.28 homing method

No. 29:

Figure 8.13 No.29 homing method
No. 30:

Figure 8.14 No.30 homing method

No. 35/37:

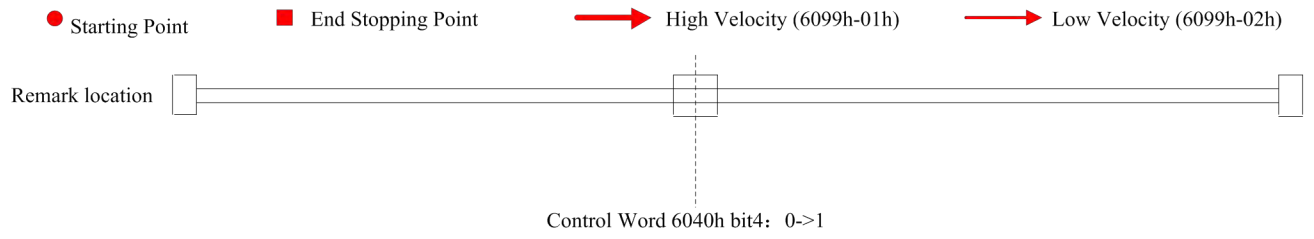

Figure 8.15 No.35/37 homing method

智業知能出品

Appendix C. Leadshine EM3E Compatible Power Supplies

It is highly suggested to use the following Leadshine power supplies to power EM3E to get optimized performance. Those power supply are specially designed for stepper and servo controls.

Model	Output Voltage (VDC)	Series Model	Continuous Current (A)	Max Current (A)	Input Voltage (VAC)
RPS2410V20	24	RPS	10	30	85-132 / 176-264
RPS3611V20	36		11	33	85-132 / 176-264
RPS488V20	48		8.3	24.9	85-132 / 176-264
RPS4810V20	48		10.5	31.5	85-132 / 176-264
RPS2410	24		10	12	85-132 / 176-264
RPS369	36		9.7	11	85-132 / 176-264
RPS488	48		7.3	8.5	85-132 / 176-264
RPS4810	48		10.4	12.5	85-132 / 176-264
SPS407	42	SPS	7.0	9.0	180-240
SPS407-L	42		4.7	9.0	90-130
SPS487	48		7.0	9.0	180-240
SPS487-L	48		3.0	9.0	90-130